

atrin **electronic**

Expertise, variety and quality



www.atrinelec.com

آترین الکترونیک

تخصص، تنوع و کیفیت

02166766957 - 02166766927



info@atrinelec.com



تهران پاساژ امجد طبقه 1 واحد 16



@atrinelec



6MBP100RA060

IGBT-IPM R series

600V / 100A 6 in one-package

Features

- Temperature protection provided by directly detecting the junction temperature of the IGBTs
- Low power loss and soft switching
- High performance and high reliability IGBT with overheating protection
- Higher reliability because of a big decrease in number of parts in built-in control circuit

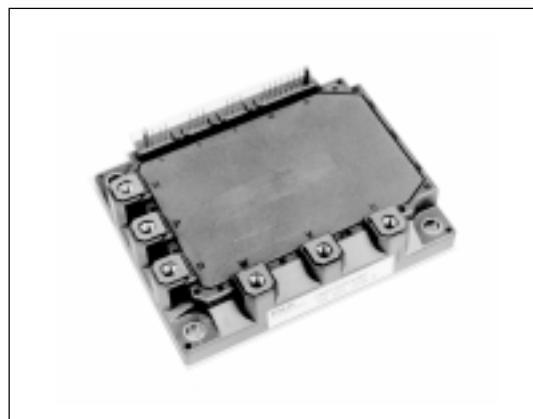

Maximum ratings and characteristics

- Absolute maximum ratings(at $T_c=25^\circ\text{C}$ unless otherwise specified)

Item	Symbol	Rating		Unit		
		Min.	Max.			
DC bus voltage	V _{DC}	0	450	V		
DC bus voltage (surge)	V _{DC(surge)}	0	500	V		
DC bus voltage (short operating)	V _{SC}	200	400	V		
Collector-Emitter voltage	V _{CES}	0	600	V		
INV	Collector current	DC	I _C	-	100	A
		1ms	I _{CP}	-	200	A
		Duty=59.5%	-I _C	-	100	A
	Collector power dissipation	One transistor	P _C	-	400	W
Junction temperature	T _j	-	150	°C		
Input voltage of power supply for Pre-Driver	V _{CC} *1	0	20	V		
Input signal voltage	V _{in} *2	0	V _Z	V		
Input signal current	I _{in}	-	1	mA		
Alarm signal voltage	V _{ALM} *3	0	V _{CC}	V		
Alarm signal current	I _{ALM} *4	-	15	mA		
Storage temperature	T _{stg}	-40	125	°C		
Operating case temperature	T _{op}	-20	100	°C		
Isolating voltage (Case-Terminal)	V _{iso} *5	-	AC2.5	kV		
Screw torque	Mounting (M5)	-	3.5 *6	N·m		
	Terminal (M5)	-	3.5 *6	N·m		

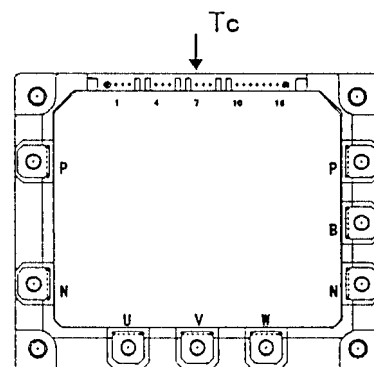

Fig.1 Measurement of case temperature

*1 Apply V_{CC} between terminal No. 3 and 1, 6 and 4, 9 and 7, 11 and 10.

*2 Apply V_{in} between terminal No. 2 and 1, 5 and 4, 8 and 7, 13,14,15 and 10.

*3 Apply V_{ALM} between terminal No. 16 and 10.

*4 Apply I_{ALM} to terminal No. 16.

*5 50Hz/60Hz sine wave 1 minute.

*6 Recommendable Value : 2.5 to 3.0 N·m

- Electrical characteristics of power circuit (at $T_c=T_j=25^\circ\text{C}$, $V_{CC}=15\text{V}$)

Item	Symbol	Condition	Min.	Typ.	Max.	Unit	
INV	Collector current at off signal input	I _{CES}	V _{CE} =600V input terminal open	-	-	1.0	mA
	Collector-Emitter saturation voltage	V _{CE(sat)}	I _C =100A	-	-	2.8	V
	Forward voltage of FWD	V _F	-I _C =100A	-	-	3.0	V

● Electrical characteristics of control circuit(at $T_c=T_j=25^{\circ}\text{C}$, $V_{cc}=15\text{V}$)

Item	Symbol	Condition	Min.	Typ.	Max.	Unit	
Power supply current of P-line side Pre-driver(one unit)	I_{ccp}	$fsw=0$ to 15kHz $T_c=-20$ to 100°C *7	3	-	18	mA	
Power supply current of N-line side three Pre-driver	I_{ccn}	$fsw=0$ to 15kHz $T_c=-20$ to 100°C *7	10	-	65	mA	
Input signal threshold voltage (on/off)	$V_{in(th)}$	ON	1.00	1.35	1.70	V	
		OFF	1.25	1.60	1.95	V	
Input zener voltage	V_z	$R_{in}=20\text{k ohm}$	-	8.0	-	V	
Over heating protection temperature level	T_{COH}	$V_{DC}=0\text{V}$, $I_c=0\text{A}$, Case temperature, Fig.1	110	-	125	$^{\circ}\text{C}$	
Hysteresis	T_{CH}		-	20	-	$^{\circ}\text{C}$	
IGBT chips over heating protection temperature level	T_{jOH}	surface of IGBT chips	150	-	-	$^{\circ}\text{C}$	
Hysteresis	T_{jH}		-	20	-	$^{\circ}\text{C}$	
Collector current protection level	INV	I_{oc}	$T_j=125^{\circ}\text{C}$	150	-	A	
Over current protection delay time		t_{DOC}	$T_j=25^{\circ}\text{C}$ Fig.2	-	10	μs	
Under voltage protection level		V_{UV}		11.0	-	12.5	V
Hysteresis		V_H		0.2	-	-	V
Alarm signal hold time		t_{ALM}		1.5	2	-	ms
SC protection delay time		t_{SC}	$T_j=25^{\circ}\text{C}$ Fig.3	-	-	12	μs
Limiting resistor for alarm		R_{ALM}		1425	1500	1575	ohm

*7 Switching frequency of IPM

● Dynamic characteristics(at $T_c=T_j=125^{\circ}\text{C}$, $V_{cc}=15\text{V}$)

Item	Symbol	Condition	Min.	Typ.	Max.	Unit
Switching time (IGBT)	t_{on}	$I_C=100\text{A}$, $V_{DC}=300\text{V}$	0.3	-	-	μs
	t_{off}		-	-	3.6	μs
Switching time (FWD)	t_{rr}	$I_F=100\text{A}$, $V_{DC}=300\text{V}$	-	-	0.4	μs

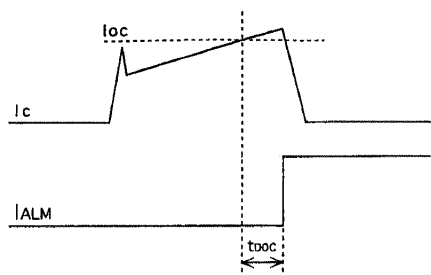

Fig.2 Definition of OC delay time

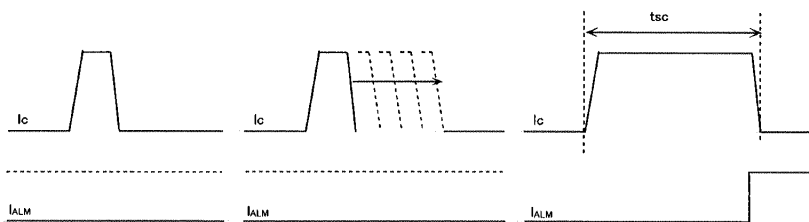

Fig.3 Definition of tsc

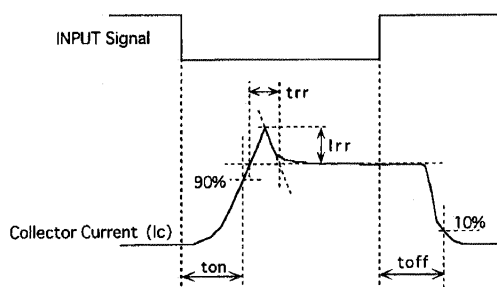

Fig.4 Definition of switching time

● Thermal characteristics($T_c=25^{\circ}\text{C}$)

Item	Symbol	Typ.	Max.	Unit	
Junction to Case thermal resistance	INV				
	IGBT	$R_{th(j-c)}$	-	0.31	$^{\circ}\text{C/W}$
	FWD	$R_{th(j-c)}$	-	0.70	$^{\circ}\text{C/W}$
Case to fin thermal resistance with compound	$R_{th(c-f)}$	0.05	-	$^{\circ}\text{C/W}$	

● Recommendable value

Item	Symbol	Min.	Typ.	Max.	Unit	
DC bus voltage	V_{DC}	200	-	400	V	
Operating power supply voltage range of Pre-driver	V_{CC}	13.5	15	16.5	V	
Switching frequency of IPM	fsw	1	-	20	kHz	
Screw torque	Mounting (M5)	-	2.5	-	3.0	N·m
	Terminal (M5)	-	2.5	-	3.0	N·m

Block diagram

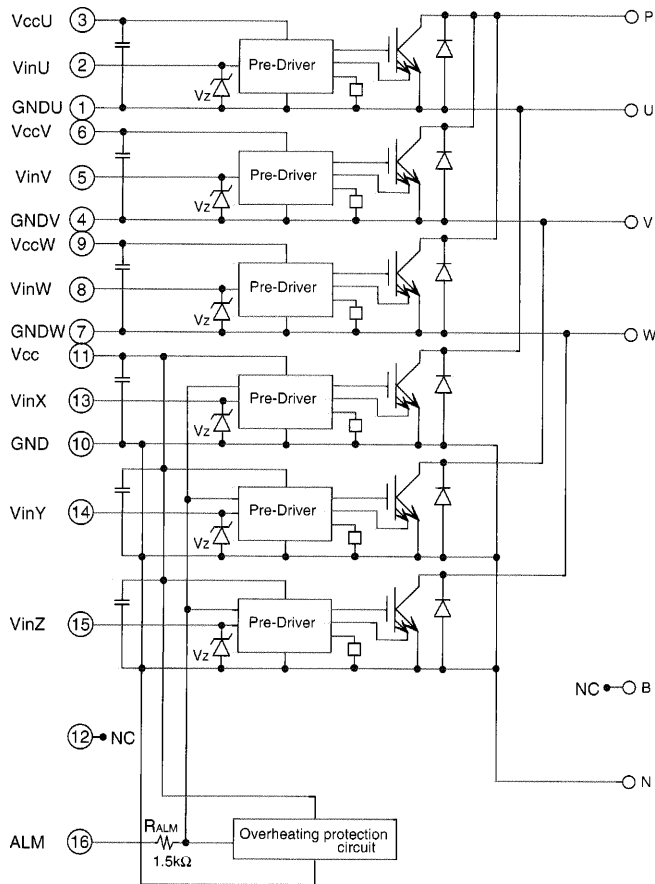

- Pre-drivers include following functions
- a) Amplifier for driver
 - b) Short circuit protection
 - c) Undervoltage lockout circuit
 - d) Over current protection
 - e) IGBT chip over heating protection

Outline drawings, mm

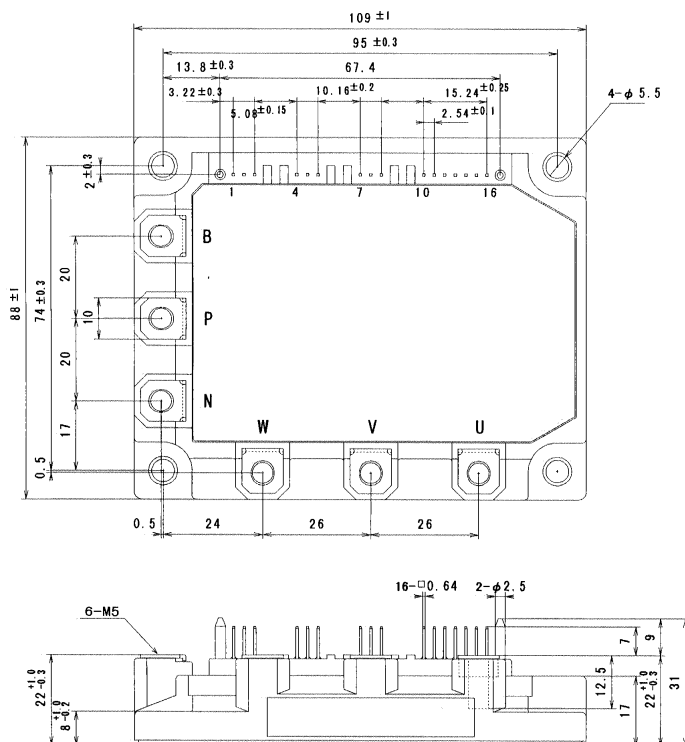

Mass : 440g

■ Characteristics (Representative)

● Control circuit

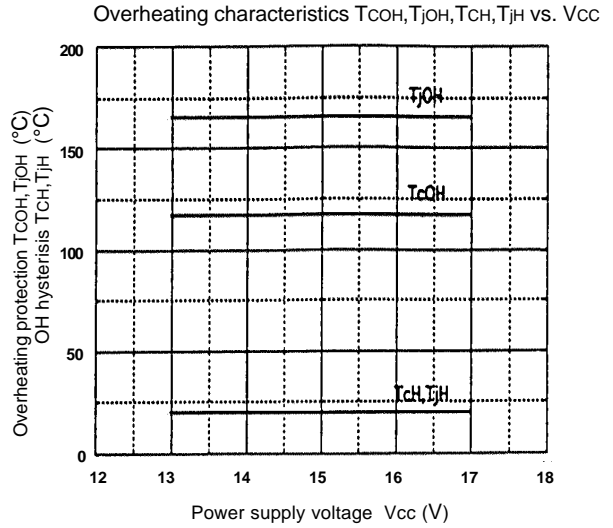
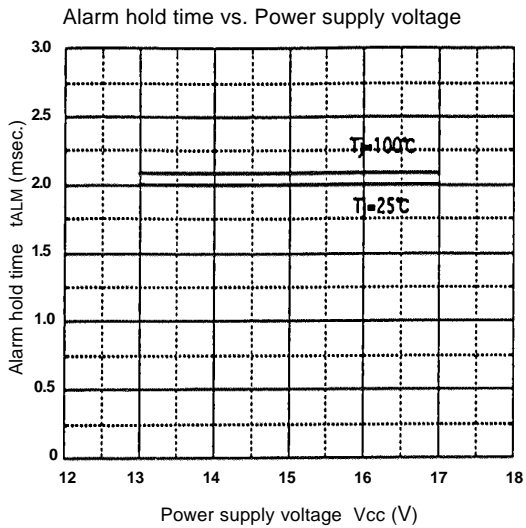
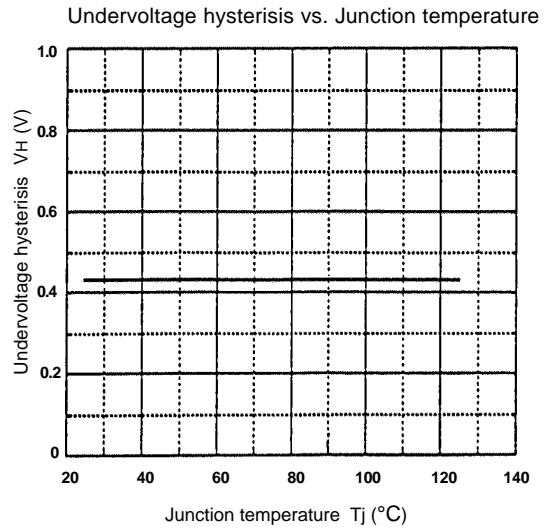
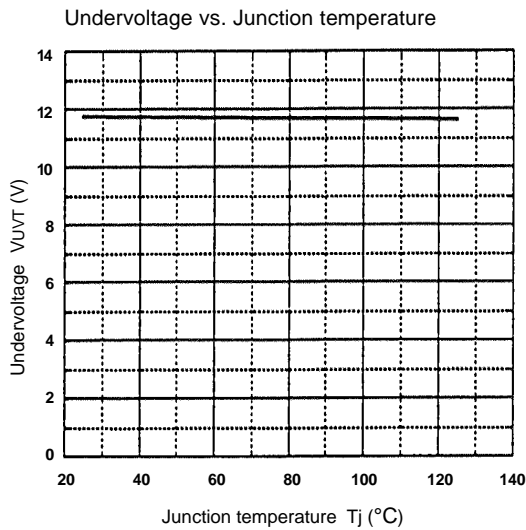
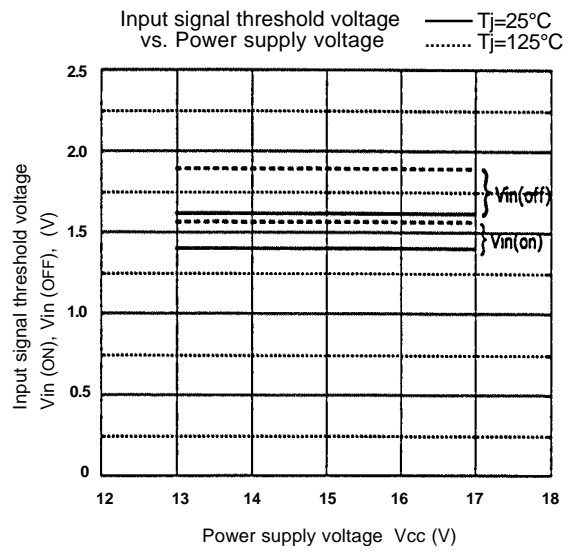
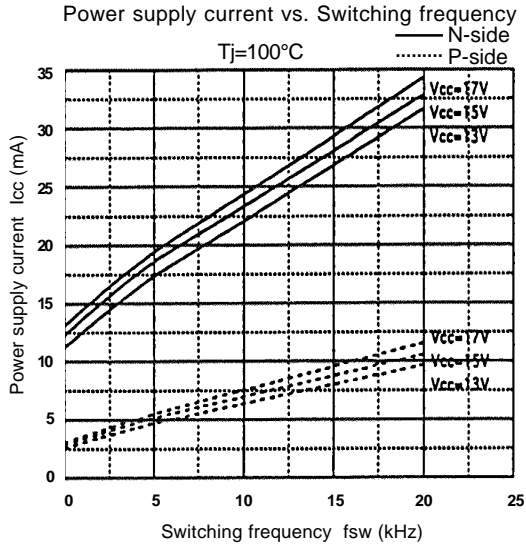

● Inverter

Collector current vs. Collector-Emitter voltage
T_j=25°C

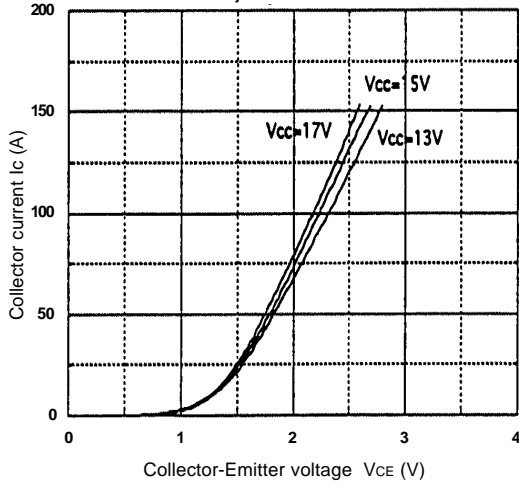

Collector current vs. Collector-Emitter voltage
T_j=125°C

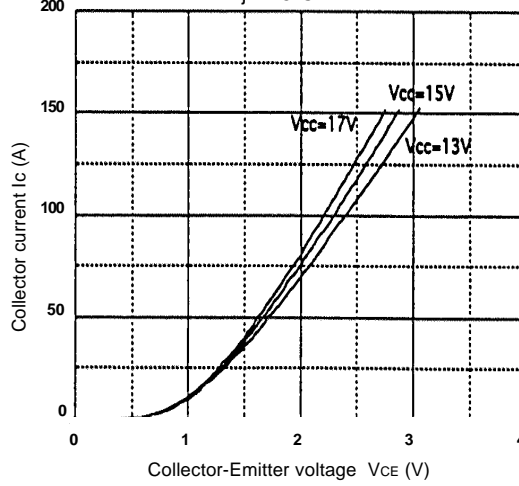

Switching time vs. Collector current
E_{dc}=300V, V_{cc}=15V, T_j=25°C

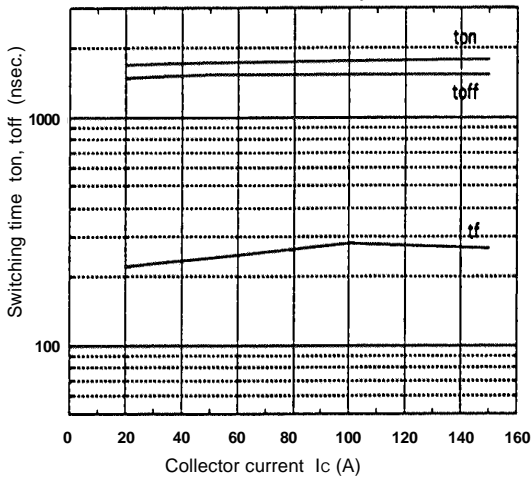

Switching time vs. Collector current
E_{dc}=300V, V_{cc}=15V, T_j=125°C

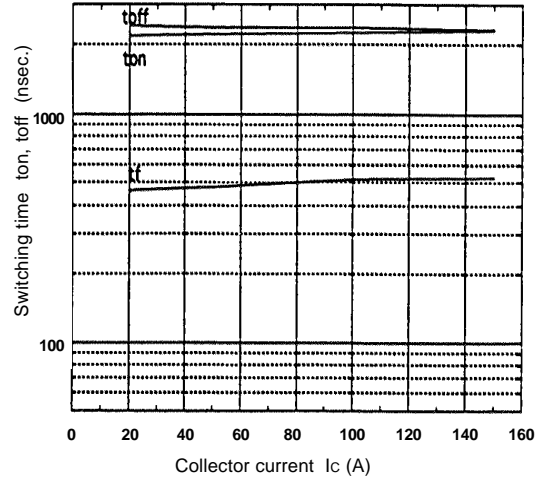

Forward current vs. Forward voltage

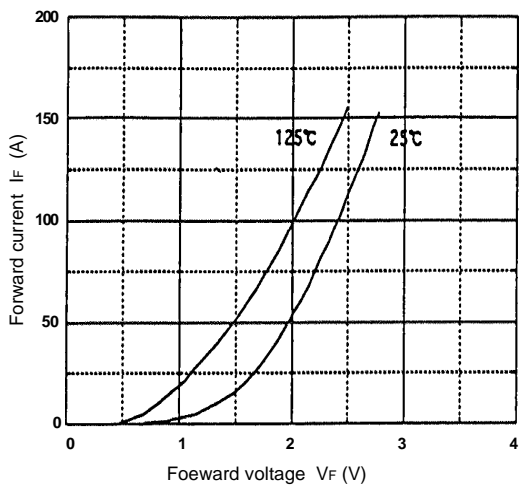

Reverse recovery characteristics trr, Irr, vs. If

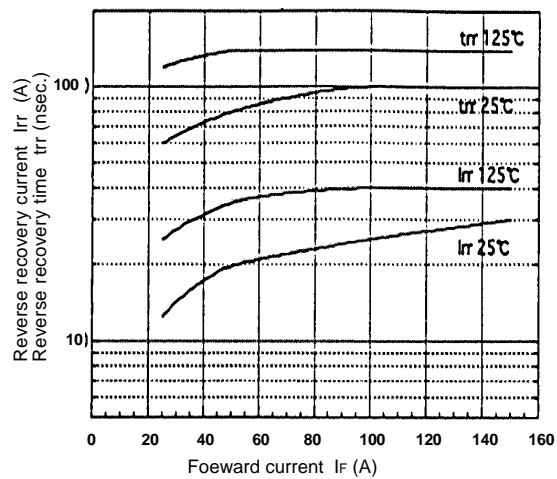

● Inverter

Transient thermal resistance

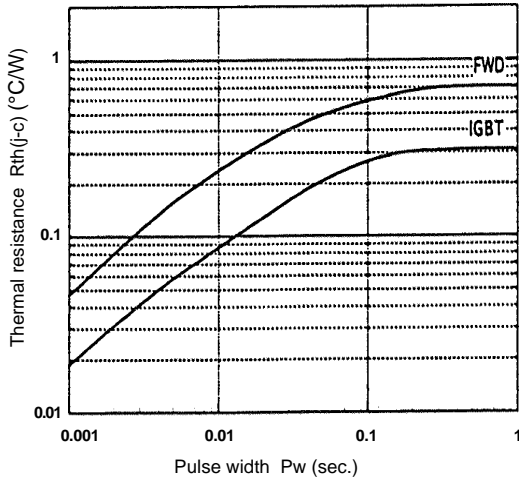

Reverse biased safe operating area
Vcc=15V, Tj ≤ 125°C

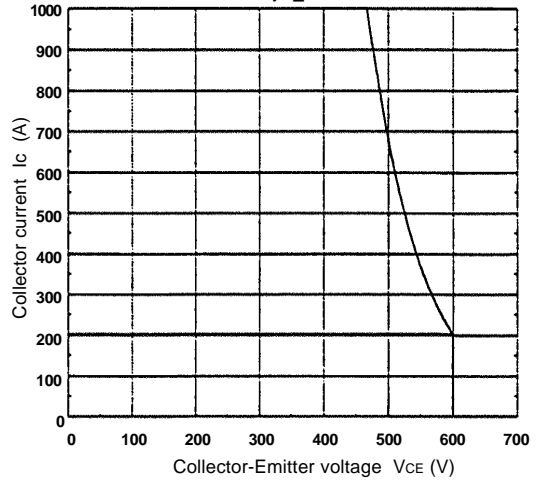

Power derating for IGBT (per device)

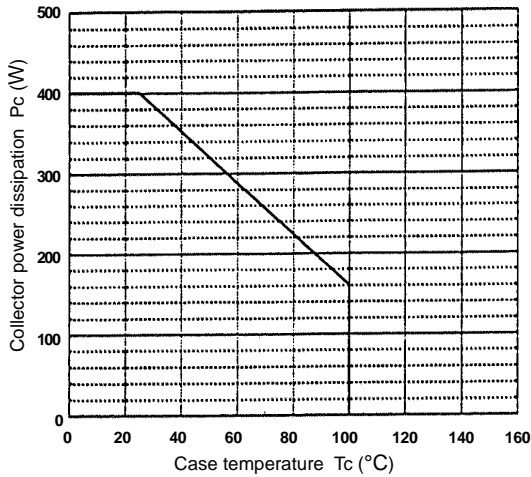

Power derating for FWD (per device)

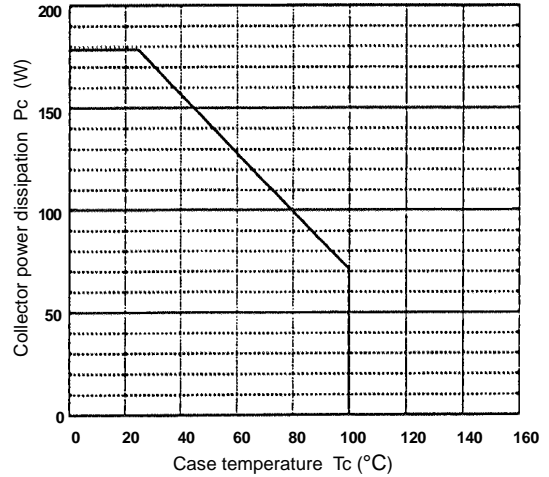

Switching loss vs. Collector current
Edc=300V, Vcc=15V, Tj=25°C

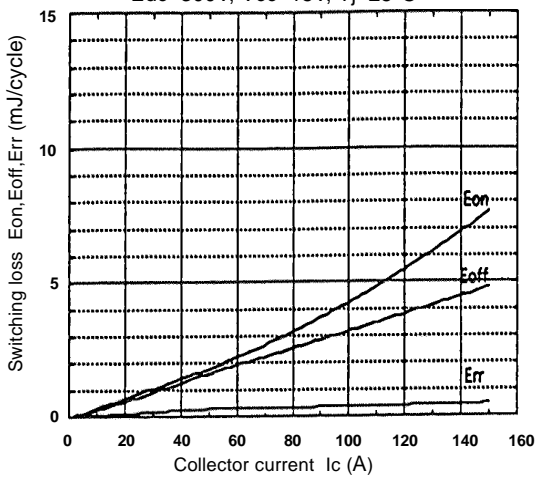

Switching loss vs. Collector current
Edc=300V, Vcc=15V, Tj=125°C

