

**atrin** **electronic**

Expertise, variety and quality



www.atrinelec.com

**آترین الکترونیک**

تخصص، تنوع و کیفیت

۰۲۱۶۶۷۰۳۶۵۲



Info@Atrinelec.com

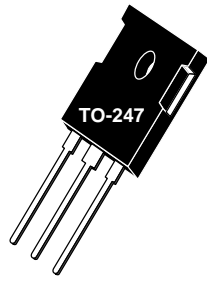
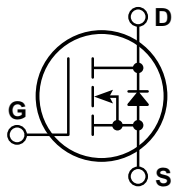


تهران، پاساژ امجد، طبقه اول، واحد ۱۶



@ATRINELEC





**APT5020BN 500V 28.0A 0.20Ω**

**APT5022BN 500V 27.0A 0.22Ω**

## POWER MOS IV®

### N-CHANNEL ENHANCEMENT MODE HIGH VOLTAGE POWER MOSFETS

#### MAXIMUM RATINGS

All Ratings:  $T_C = 25^\circ\text{C}$  unless otherwise specified.

Symbol	Parameter	APT 5020BN	APT 5022BN	UNIT
$V_{DSS}$	Drain-Source Voltage	500	500	Volts
$I_D$	Continuous Drain Current @ $T_C = 25^\circ\text{C}$	28	27	Amps
$I_{DM}$	Pulsed Drain Current <sup>①</sup>	112	108	
$V_{GS}$	Gate-Source Voltage	$\pm 30$		Volts
$P_D$	Total Power Dissipation @ $T_C = 25^\circ\text{C}$	360		Watts
	Linear Derating Factor	2.9		W/°C
$T_J, T_{STG}$	Operating and Storage Junction Temperature Range	-55 to 150		°C
$T_L$	Lead Temperature: 0.063" from Case for 10 Sec.	300		

#### STATIC ELECTRICAL CHARACTERISTICS

Symbol	Characteristic / Test Conditions / Part Number	MIN	TYP	MAX	UNIT
$BV_{DSS}$	Drain-Source Breakdown Voltage ( $V_{GS} = 0V, I_D = 250 \mu\text{A}$ )	APT5020BN	500		Volts
		APT5022BN	500		
$I_{D(ON)}$	On State Drain Current <sup>②</sup> ( $V_{DS} > I_{D(ON)} \times R_{DS(ON)}$ Max, $V_{GS} = 10V$ )	APT5020BN	28		Amps
		APT5022BN	27		
$R_{DS(ON)}$	Drain-Source On-State Resistance <sup>②</sup> ( $V_{GS} = 10V, 0.5 I_D$ [Cont.])	APT5020BN		0.20	Ohms
		APT5022BN		0.22	
$I_{DSS}$	Zero Gate Voltage Drain Current ( $V_{DS} = V_{DSS}, V_{GS} = 0V$ )			250	$\mu\text{A}$
	Zero Gate Voltage Drain Current ( $V_{DS} = 0.8 V_{DSS}, V_{GS} = 0V, T_C = 125^\circ\text{C}$ )			1000	
$I_{GSS}$	Gate-Source Leakage Current ( $V_{GS} = \pm 30V, V_{DS} = 0V$ )			$\pm 100$	nA
$V_{GS(TH)}$	Gate Threshold Voltage ( $V_{DS} = V_{GS}, I_D = 1.0\text{mA}$ )	2		4	Volts

#### THERMAL CHARACTERISTICS

Symbol	Characteristic	MIN	TYP	MAX	UNIT
$R_{\theta JC}$	Junction to Case			0.34	°C/W
$R_{\theta JA}$	Junction to Ambient			40	



**CAUTION:** These Devices are Sensitive to Electrostatic Discharge. Proper Handling Procedures Should Be Followed.

#### USA

405 S.W. Columbia Street  
EUROPE

Avenue J.F. Kennedy Bât B4 Parc Cadéra Nord

Bend, Oregon 97702-1035

F-33700 Merignac - France

Phone: (541) 382-8028

Phone: (33) 5 57 92 15 15

FAX: (541) 388-0364

FAX: (33) 5 56 47 97 61

**DYNAMIC CHARACTERISTICS**

**APT5020/5022BN**

Symbol	Characteristic	Test Conditions	MIN	TYP	MAX	UNIT
$C_{iss}$	Input Capacitance	$V_{GS} = 0V$ $V_{DS} = 25V$ $f = 1\text{ MHz}$		2890	3500	pF
$C_{oss}$	Output Capacitance			590	830	
$C_{rss}$	Reverse Transfer Capacitance			230	350	
$Q_g$	Total Gate Charge ③	$V_{GS} = 10V$ $V_{DD} = 0.5 V_{DSS}$ $I_D = I_D [\text{Cont.}] @ 25^\circ\text{C}$		140	210	nC
$Q_{gs}$	Gate-Source Charge			18	27	
$Q_{gd}$	Gate-Drain ("Miller") Charge			75	110	
$t_d(\text{on})$	Turn-on Delay Time	$V_{GS} = 15V$ $V_{DD} = 0.5 V_{DSS}$ $I_D = I_D [\text{Cont.}] @ 25^\circ\text{C}$ $R_G = 1.8\Omega$		19	38	ns
$t_r$	Rise Time			43	86	
$t_d(\text{off})$	Turn-off Delay Time			85	125	
$t_f$	Fall Time			56	112	

**SOURCE-DRAIN DIODE RATINGS AND CHARACTERISTICS**

Symbol	Characteristic / Test Conditions / Part Number	MIN	TYP	MAX	UNIT
$I_S$	Continuous Source Current (Body Diode)	APT5020BN		28	Amps
		APT5022BN		27	
$I_{SM}$	Pulsed Source Current ① (Body Diode)	APT5020BN		112	Amps
		APT5022BN		108	
$V_{SD}$	Diode Forward Voltage ② ( $V_{GS} = 0V, I_S = -I_D [\text{Cont.}]$ )			1.3	Volts
$t_{rr}$	Reverse Recovery Time ( $I_S = -I_D [\text{Cont.}], di_S/dt = 100A/\mu s$ )	215	430	860	ns
$Q_{rr}$	Reverse Recovery Charge ( $I_S = -I_D [\text{Cont.}], di_S/dt = 100A/\mu s$ )	3	7	14	$\mu C$

**SAFE OPERATING AREA CHARACTERISTICS**

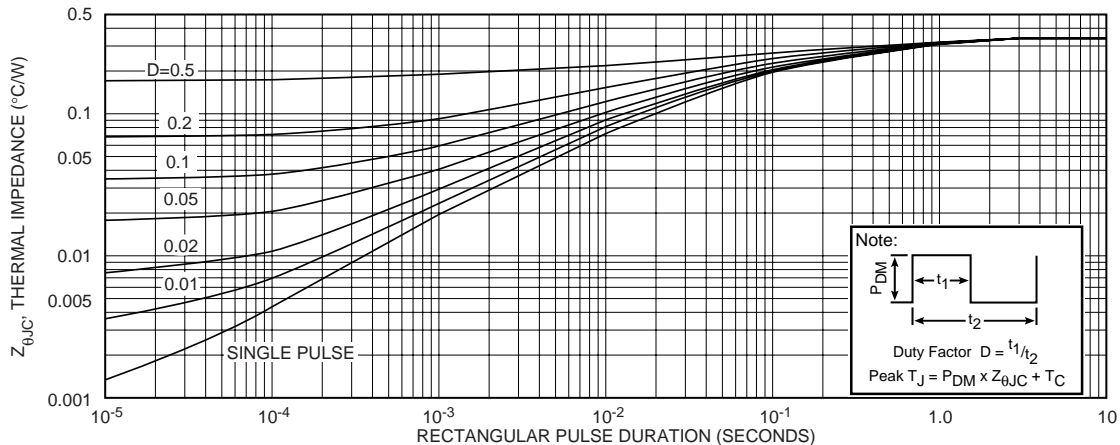
Symbol	Characteristic	Test Conditions / Part Number	MIN	TYP	MAX	UNIT
SOA1	Safe Operating Area	$V_{DS} = 0.4 V_{DSS}, I_{DS} = P_D / 0.4 V_{DSS}, t = 1\text{ Sec.}$	360			Watts
SOA2	Safe Operating Area	$I_{DS} = I_D [\text{Cont.}], V_{DS} = P_D / I_D [\text{Cont.}], t = 1\text{ Sec.}$	360			
$I_{LM}$	Inductive Current Clamped	APT5020BN	112			Amps
		APT5022BN	108			

① Repetitive Rating: Pulse width limited by maximum junction temperature. See Transient Thermal Impedance Curve. (Fig.1)

② Pulse Test: Pulse width < 380  $\mu s$ , Duty Cycle < 2%

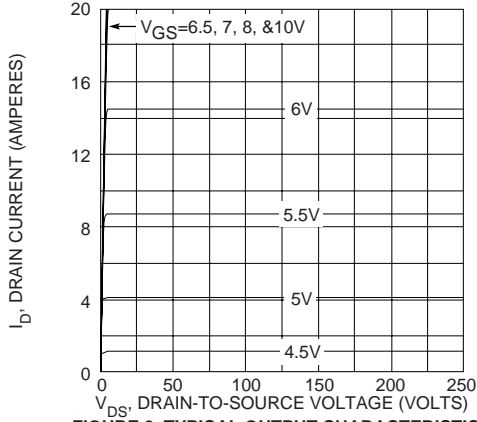
③ See MIL-STD-750 Method 3471

APT Reserves the right to change, without notice, the specifications and information contained herein.

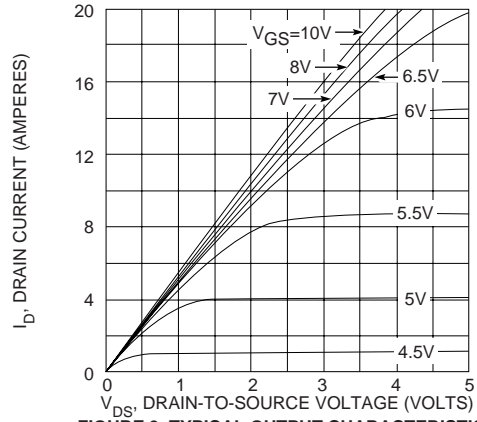


**FIGURE 1, MAXIMUM EFFECTIVE TRANSIENT THERMAL IMPEDANCE, JUNCTION-TO-CASE vs PULSE DURATION**

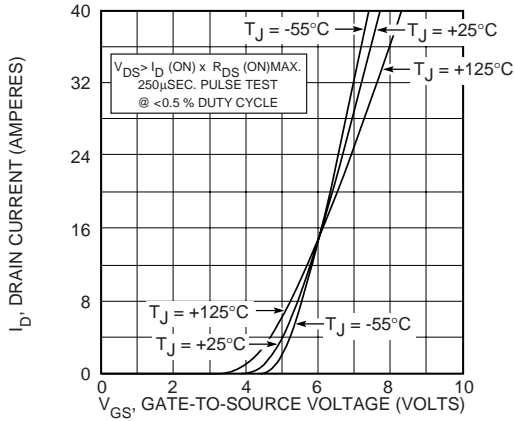
**APT5020/5022BN**



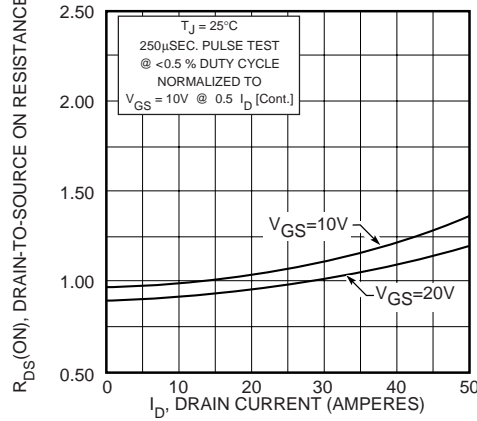
**FIGURE 2, TYPICAL OUTPUT CHARACTERISTICS**



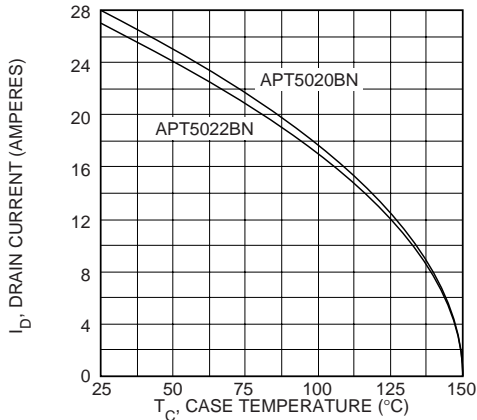
**FIGURE 3, TYPICAL OUTPUT CHARACTERISTICS**



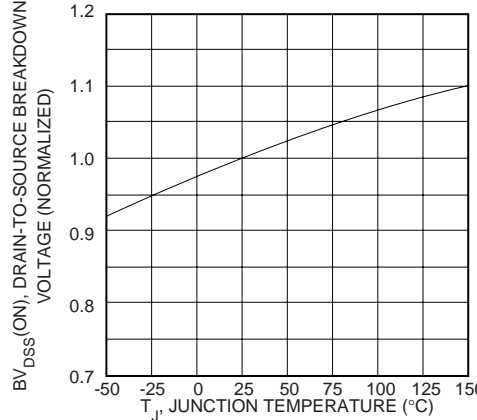
**FIGURE 4, TYPICAL TRANSFER CHARACTERISTICS**



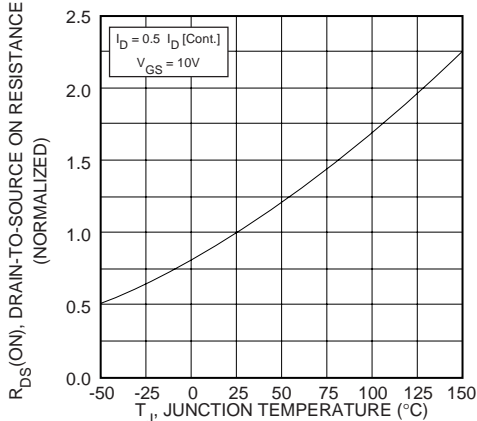
**FIGURE 5,  $R_{DS(ON)}$  vs DRAIN CURRENT**



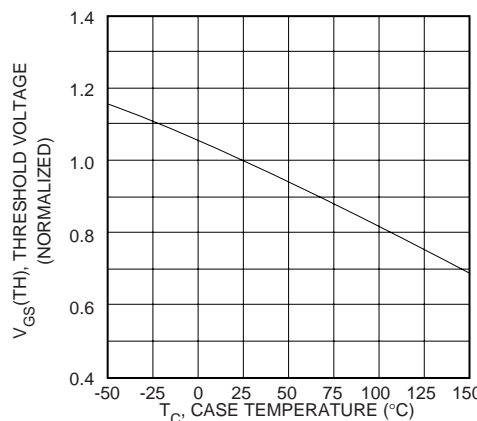
**FIGURE 6, MAXIMUM DRAIN CURRENT vs CASE TEMPERATURE**



**FIGURE 7, BREAKDOWN VOLTAGE vs TEMPERATURE**

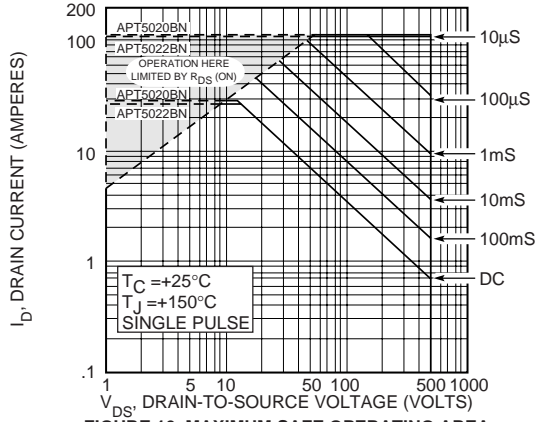


**FIGURE 8, ON-RESISTANCE vs. TEMPERATURE**

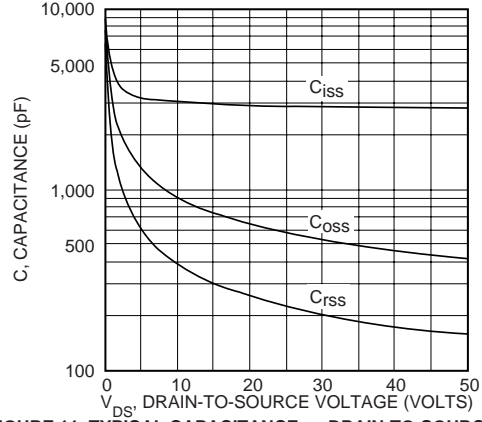


**FIGURE 9, THRESHOLD VOLTAGE vs TEMPERATURE**

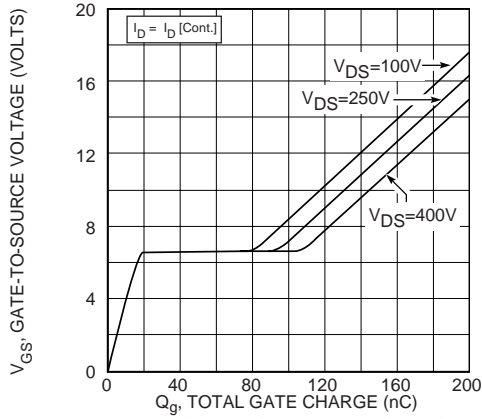
**APT5020/5022BN**



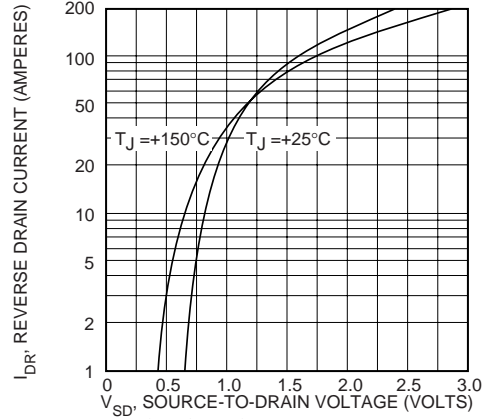
**FIGURE 10, MAXIMUM SAFE OPERATING AREA**



**FIGURE 11, TYPICAL CAPACITANCE vs DRAIN-TO-SOURCE VOLTAGE**

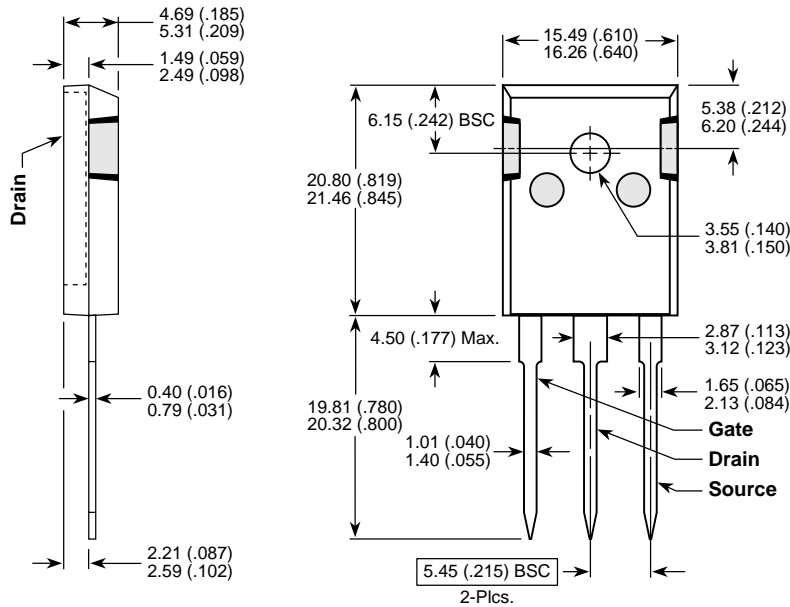


**FIGURE 12, GATE CHARGES vs GATE-TO-SOURCE VOLTAGE**



**FIGURE 13, TYPICAL SOURCE-DRAIN DIODE FORWARD VOLTAGE**

**TO-247AD Package Outline**



Dimensions in Millimeters and (Inches)