

atrin **electronic**

Expertise, variety and quality



www.atrinelec.com

آترین الکترونیک

تخصص، تنوع و کیفیت

02166766957 - 02166766927



info@atrinelec.com



تهران پاساژ امجد طبقه 1 واحد 16



@atrinelec



Technische Information / Technical Information

IGBT-Module
IGBT-Modules

BSM10GP120

eupec

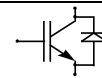

Elektrische Eigenschaften / Electrical properties

Höchstzulässige Werte / Maximum rated values

Diode Gleichrichter/ Diode Rectifier

Periodische Rückw. Spitzensperrspannung repetitive peak reverse voltage		V_{RRM}	1600	V
Durchlaßstrom Grenzeffektivwert RMS forward current per chip		I_{FRMSM}	40	A
Dauergleichstrom DC forward current	$T_C = 80^\circ\text{C}$	I_d	10	A
Stoßstrom Grenzwert surge forward current	$t_p = 10\text{ ms}, T_{vj} = 25^\circ\text{C}$	I_{FSM}	300	A
	$t_p = 10\text{ ms}, T_{vj} = 150^\circ\text{C}$		230	A
Grenzlastintegral I^2t - value	$t_p = 10\text{ ms}, T_{vj} = 25^\circ\text{C}$	I^2t	450	A^2s
	$t_p = 10\text{ ms}, T_{vj} = 150^\circ\text{C}$		260	A^2s

Transistor Wechselrichter/ Transistor Inverter

Kollektor-Emitter-Sperrspannung collector-emitter voltage		V_{CES}	1200	V
Kollektor-Dauergleichstrom DC-collector current	$T_C = 80^\circ\text{C}$	$I_{C,nom.}$	10	A
	$T_C = 25^\circ\text{C}$	I_C	20	A
Periodischer Kollektor Spitzenstrom repetitive peak collector current	$t_p = 1\text{ ms}, T_C = 80^\circ\text{C}$	I_{CRM}	20	A
Gesamt-Verlustleistung total power dissipation	$T_C = 25^\circ\text{C}$	P_{tot}	100	W
Gate-Emitter-Spitzenspannung gate-emitter peak voltage		V_{GES}	+/- 20V	V

Diode Wechselrichter/ Diode Inverter

Dauergleichstrom DC forward current	$T_C = 80^\circ\text{C}$	I_F	10	A
Periodischer Spitzenstrom repetitive peak forw. current	$t_p = 1\text{ ms}$	I_{FRM}	20	A
Grenzlastintegral I^2t - value	$V_R = 0\text{V}, t_p = 10\text{ms}, T_{vj} = 125^\circ\text{C}$	I^2t	18	A^2s

Transistor Brems-Chopper/ Transistor Brake-Chopper

Kollektor-Emitter-Sperrspannung collector-emitter voltage		V_{CES}	1200	V
Kollektor-Dauergleichstrom DC-collector current	$T_C = 80^\circ\text{C}$	$I_{C,nom.}$	10	A
	$T_C = 25^\circ\text{C}$	I_C	20	A
Periodischer Kollektor Spitzenstrom repetitive peak collector current	$t_p = 1\text{ ms}, T_C = 80^\circ\text{C}$	I_{CRM}	20	A
Gesamt-Verlustleistung total power dissipation	$T_C = 25^\circ\text{C}$	P_{tot}	100	W
Gate-Emitter-Spitzenspannung gate-emitter peak voltage		V_{GES}	+/- 20V	V

Diode Brems-Chopper/ Diode Brake-Chopper

Dauergleichstrom DC forward current	$T_C = 80^\circ\text{C}$	I_F	10	A
Periodischer Spitzenstrom repetitive peak forw. current	$t_p = 1\text{ ms}$	I_{FRM}	20	A

prepared by: Andreas Schulz	date of publication: 17.09.1999
approved by: M.Hierholzer	revision: 5

Technische Information / Technical Information

IGBT-Module
IGBT-Modules

BSM10GP120

eupec

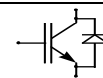

Modul Isolation/ Module Isolation

Isolations-Prüfspannung insulation test voltage	RMS, f = 50 Hz, t = 1 min. NTC connected to Baseplate	V_{ISOL}	2,5	kV
--	--	------------	-----	----

Elektrische Eigenschaften / Electrical properties

Charakteristische Werte / Characteristic values

Diode Gleichrichter/ Diode Rectifier		min.	typ.	max.	
Durchlaßspannung forward voltage	$T_{vj} = 150^{\circ}\text{C}$, $I_F = 10\text{ A}$	V_F	-	0,9	0,95 V
Schleusenspannung threshold voltage	$T_{vj} = 150^{\circ}\text{C}$	$V_{(TO)}$	-	-	0,8 V
Ersatzwiderstand slope resistance	$T_{vj} = 150^{\circ}\text{C}$	r_T	-	-	10,5 mΩ
Sperrstrom reverse current	$T_{vj} = 150^{\circ}\text{C}$, $V_R = 1600\text{ V}$	I_R	-	2	- mA
Modul Leitungswiderstand, Anschlüsse-Chip lead resistance, terminals-chip	$T_C = 25^{\circ}\text{C}$	$R_{AA'+CC'}$	-	8	- mΩ

Transistor Wechselrichter/ Transistor Inverter		min.	typ.	max.	
Kollektor-Emitter Sättigungsspannung collector-emitter saturation voltage	$V_{GE} = 15\text{V}$, $T_{vj} = 25^{\circ}\text{C}$, $I_C = 10\text{ A}$	$V_{CE\text{ sat}}$	-	2,4	2,85 V
	$V_{GE} = 15\text{V}$, $T_{vj} = 125^{\circ}\text{C}$, $I_C = 10\text{ A}$		-	2,75	- V
Gate-Schwellenspannung gate threshold voltage	$V_{CE} = V_{GE}$, $T_{vj} = 25^{\circ}\text{C}$, $I_C = 0,35\text{ mA}$	$V_{GE(TO)}$	4,5	5,5	6,5 V
Eingangskapazität input capacitance	f = 1MHz, $T_{vj} = 25^{\circ}\text{C}$ $V_{CE} = 25\text{ V}$, $V_{GE} = 0\text{ V}$	C_{ies}	-	0,6	- nF
Kollektor-Emitter Reststrom collector-emitter cut-off current	$V_{GE} = 0\text{V}$, $T_{vj} = 25^{\circ}\text{C}$, $V_{CE} = 1200\text{ V}$	I_{CES}	-	0,5	500 μA
	$V_{GE} = 0\text{V}$, $T_{vj} = 125^{\circ}\text{C}$, $V_{CE} = 1200\text{ V}$		-	0,8	- mA
Gate-Emitter Reststrom gate-emitter leakage current	$V_{CE} = 0\text{V}$, $V_{GE} = 20\text{V}$, $T_{vj} = 25^{\circ}\text{C}$	I_{GES}	-	-	300 nA
Einschaltverzögerungszeit (ind. Last) turn on delay time (inductive load)	$I_C = I_{Nenn}$, $V_{CC} = 600\text{ V}$	$t_{d,on}$	-	40	- ns
	$V_{GE} = \pm 15\text{V}$, $T_{vj} = 25^{\circ}\text{C}$, $R_G = 82\text{ Ohm}$				
	$V_{GE} = \pm 15\text{V}$, $T_{vj} = 125^{\circ}\text{C}$, $R_G = 82\text{ Ohm}$				
Anstiegszeit (induktive Last) rise time (inductive load)	$I_C = I_{Nenn}$, $V_{CC} = 600\text{ V}$	t_r	-	45	- ns
	$V_{GE} = \pm 15\text{V}$, $T_{vj} = 25^{\circ}\text{C}$, $R_G = 82\text{ Ohm}$				
	$V_{GE} = \pm 15\text{V}$, $T_{vj} = 125^{\circ}\text{C}$, $R_G = 82\text{ Ohm}$				
Abschaltverzögerungszeit (ind. Last) turn off delay time (inductive load)	$I_C = I_{Nenn}$, $V_{CC} = 600\text{ V}$	$t_{d,off}$	-	255	- ns
	$V_{GE} = \pm 15\text{V}$, $T_{vj} = 25^{\circ}\text{C}$, $R_G = 82\text{ Ohm}$				
	$V_{GE} = \pm 15\text{V}$, $T_{vj} = 125^{\circ}\text{C}$, $R_G = 82\text{ Ohm}$				
Fallzeit (induktive Last) fall time (inductive load)	$I_C = I_{Nenn}$, $V_{CC} = 600\text{ V}$	t_f	-	40	- ns
	$V_{GE} = \pm 15\text{V}$, $T_{vj} = 25^{\circ}\text{C}$, $R_G = 82\text{ Ohm}$				
	$V_{GE} = \pm 15\text{V}$, $T_{vj} = 125^{\circ}\text{C}$, $R_G = 82\text{ Ohm}$				
Einschaltverlustenergie pro Puls turn-on energy loss per pulse	$I_C = I_{Nenn}$, $V_{CC} = 600\text{ V}$ $V_{GE} = \pm 15\text{V}$, $T_{vj} = 125^{\circ}\text{C}$, $R_G = 82\text{ Ohm}$ $L_S = 75\text{ nH}$	E_{on}	-	1,2	- mWs
Abschaltverlustenergie pro Puls turn-off energy loss per pulse	$I_C = I_{Nenn}$, $V_{CC} = 600\text{ V}$ $V_{GE} = \pm 15\text{V}$, $T_{vj} = 125^{\circ}\text{C}$, $R_G = 82\text{ Ohm}$ $L_S = 75\text{ nH}$	E_{off}	-	1,1	- mWs
Kurzschlußverhalten SC Data	$t_P \leq 10\mu\text{s}$, $V_{GE} \leq 15\text{V}$, $R_G = 82\text{ Ohm}$ $T_{vj} \leq 125^{\circ}\text{C}$, $V_{CC} = 720\text{ V}$ $dI/dt = 800\text{ A}/\mu\text{s}$	I_{SC}	-	45	- A

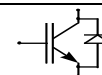

Elektrische Eigenschaften / Electrical properties

Charakteristische Werte / Characteristic values

		min.	typ.	max.			
Modulinduktivität stray inductance module		$L_{\sigma CE}$	-	-	100 nH		
Modul Leitungswiderstand, Anschlüsse-Chip lead resistance, terminals-chip	$T_C = 25^\circ C$	$R_{CC'+EE'}$	-	11	- mΩ		
Diode Wechselrichter/ Diode Inverter		min.		typ.		max.	
Durchlaßspannung forward voltage	$V_{GE} = 0V, T_{vj} = 25^\circ C, I_F = 10 A$ $V_{GE} = 0V, T_{vj} = 125^\circ C, I_F = 10 A$	V_F	-	2,2	2,55	V	
Rückstromspitze peak reverse recovery current	$I_F = I_{Nenn}, - di_F/dt = 400A/\mu s$ $V_{GE} = -10V, T_{vj} = 25^\circ C, V_R = 600 V$ $V_{GE} = -10V, T_{vj} = 125^\circ C, V_R = 600 V$	I_{RM}	-	11	-	A	
Sperrverzögerungsladung recovered charge	$I_F = I_{Nenn}, - di_F/dt = 400A/\mu s$ $V_{GE} = -10V, T_{vj} = 25^\circ C, V_R = 600 V$ $V_{GE} = -10V, T_{vj} = 125^\circ C, V_R = 600 V$	Q_r	-	0,84	-	μAs	
Abschaltenergie pro Puls reverse recovery energy	$I_F = I_{Nenn}, - di_F/dt = 400A/\mu s$ $V_{GE} = -10V, T_{vj} = 25^\circ C, V_R = 600 V$ $V_{GE} = -10V, T_{vj} = 125^\circ C, V_R = 600 V$	E_{RQ}	-	0,3	-	mWs	
Transistor Brems-Chopper/ Transistor Brake-Chopper		min.		typ.		max.	
Kollektor-Emitter Sättigungsspannung collector-emitter saturation voltage	$V_{GE} = 15V, T_{vj} = 25^\circ C, I_C = 10,0 A$ $V_{GE} = 15V, T_{vj} = 125^\circ C, I_C = 10,0 A$	$V_{CE sat}$	-	2,4	2,85	V	
Gate-Schwellenspannung gate threshold voltage	$V_{CE} = V_{GE}, T_{vj} = 25^\circ C, I_C = 0,35mA$	$V_{GE(TO)}$	4,5	5,5	6,5	V	
Eingangskapazität input capacitance	$f = 1MHz, T_{vj} = 25^\circ C$ $V_{CE} = 25 V, V_{GE} = 0 V$	C_{ies}	-	0,6	-	nF	
Kollektor-Emitter Reststrom collector-emitter cut-off current	$V_{GE} = 0V, T_{vj} = 25^\circ C, V_{CE} = 1200 V$ $V_{GE} = 0V, T_{vj} = 125^\circ C, V_{CE} = 1200 V$	I_{CES}	-	0,5	500	μA	
Gate-Emitter Reststrom gate-emitter leakage current	$V_{CE} = 0V, V_{GE} = 20V, T_{vj} = 25^\circ C$	I_{GES}	-	-	300	nA	
Diode Brems-Chopper/ Diode Brake-Chopper		min.		typ.		max.	
Durchlaßspannung forward voltage	$T_{vj} = 25^\circ C, I_F = 10,0 A$ $T_{vj} = 125^\circ C, I_F = 10,0 A$	V_F	-	2,2	2,55	V	
NTC-Widerstand/ NTC-Thermistor		min.		typ.		max.	
Nennwiderstand rated resistance	$T_C = 25^\circ C$	R_{25}	-	5	-	kΩ	
Abweichung von R_{100} deviation of R_{100}	$T_C = 100^\circ C, R_{100} = 493 \Omega$	$\Delta R/R$	-5		5	%	
Verlustleistung power dissipation	$T_C = 25^\circ C$	P_{25}			20	mW	
B-Wert B-value	$R_2 = R_1 \exp [B(1/T_2 - 1/T_1)]$	$B_{25/50}$		3375		K	

Technische Information / Technical Information

IGBT-Module
IGBT-Modules

BSM10GP120

eupec

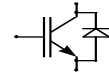

Thermische Eigenschaften / Thermal properties

		min.	typ.	max.		
Innerer Wärmewiderstand thermal resistance, junction to case	Gleichr. Diode/ Rectif. Diode	R_{thJC}	-	-	1	K/W
	Trans. Wechr./ Trans. Inverter		-	-	1,2	K/W
	Diode Wechr./ Diode Inverter		-	-	2,3	K/W
	Trans. Bremse/ Trans. Brake		-	-	1,2	K/W
	Diode Bremse/ Diode Brake		-	-	2,3	K/W
Übergangs-Wärmewiderstand thermal resistance, case to heatsink	Gleichr. Diode/ Rectif. Diode	R_{thCK}	-	0,08	-	K/W
	Trans. Wechr./ Trans. Inverter	$\lambda_{paste}=1W/m^2K$	-	0,04	-	K/W
	Diode Wechr./ Diode Inverter	$\lambda_{grease}=1W/m^2K$	-	0,08	-	K/W
Höchstzulässige Sperrschichttemperatur maximum junction temperature		T_{vj}	-	-	150	°C
Betriebstemperatur operation temperature		T_{op}	-40	-	125	°C
Lagertemperatur storage temperature		T_{stg}	-40	-	125	°C

Mechanische Eigenschaften / Mechanical properties

Innere Isolation internal insulation				Al_2O_3	
CTI comperative tracking index				225	
Anzugsdrehmoment f. mech. Befestigung mounting torque		M		3 $\pm 10\%$	Nm
Gewicht weight		G		180	g

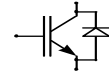

Ausgangskennlinienfeld Wechselr. (typisch)

$d = f(V_{CE})$

Output characteristic Inverter (typical)

$V_{GE} = 15\text{ V}$

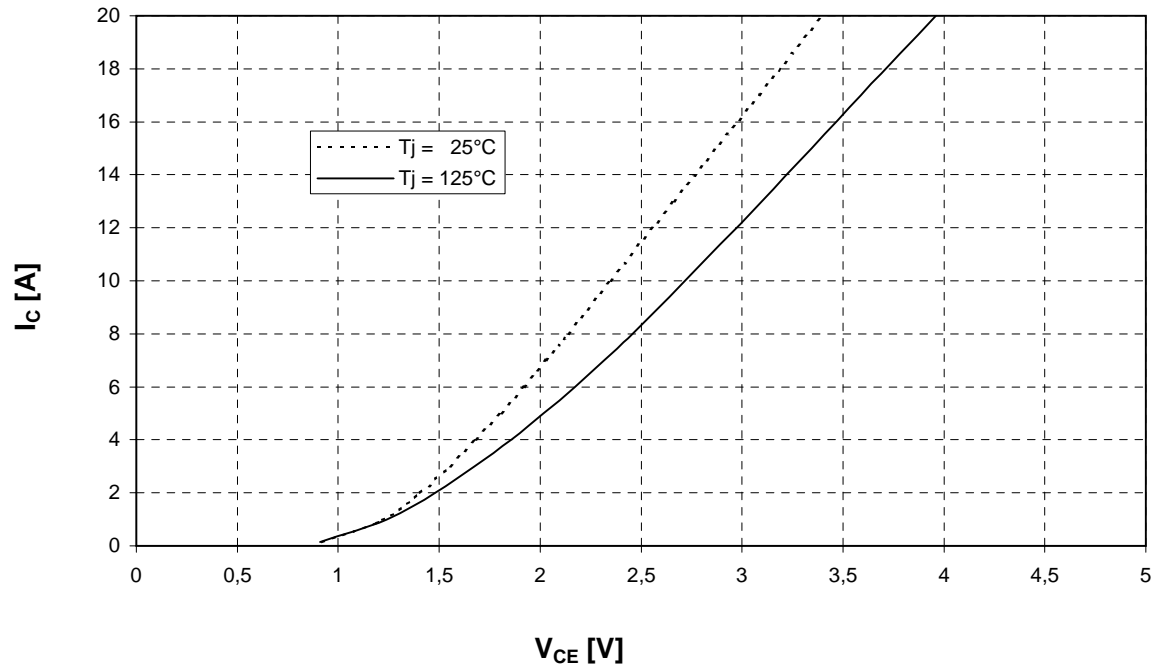

Ausgangskennlinienfeld Wechselr. (typisch)

$d = f(V_{CE})$

Output characteristic Inverter (typical)

$T_{vj} = 125^\circ\text{C}$

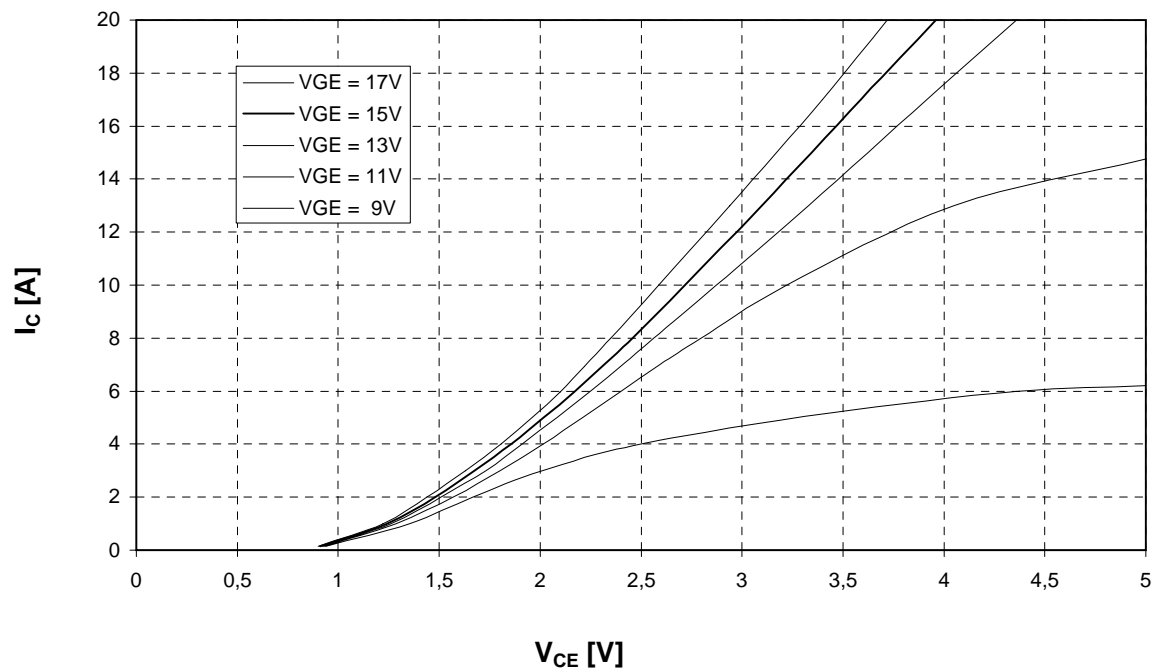

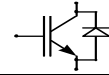

Übertragungscharakteristik Wechselr. (typisch)

Transfer characteristic Inverter (typical)

$i_c = f(V_{GE})$

$V_{CE} = 20\text{ V}$

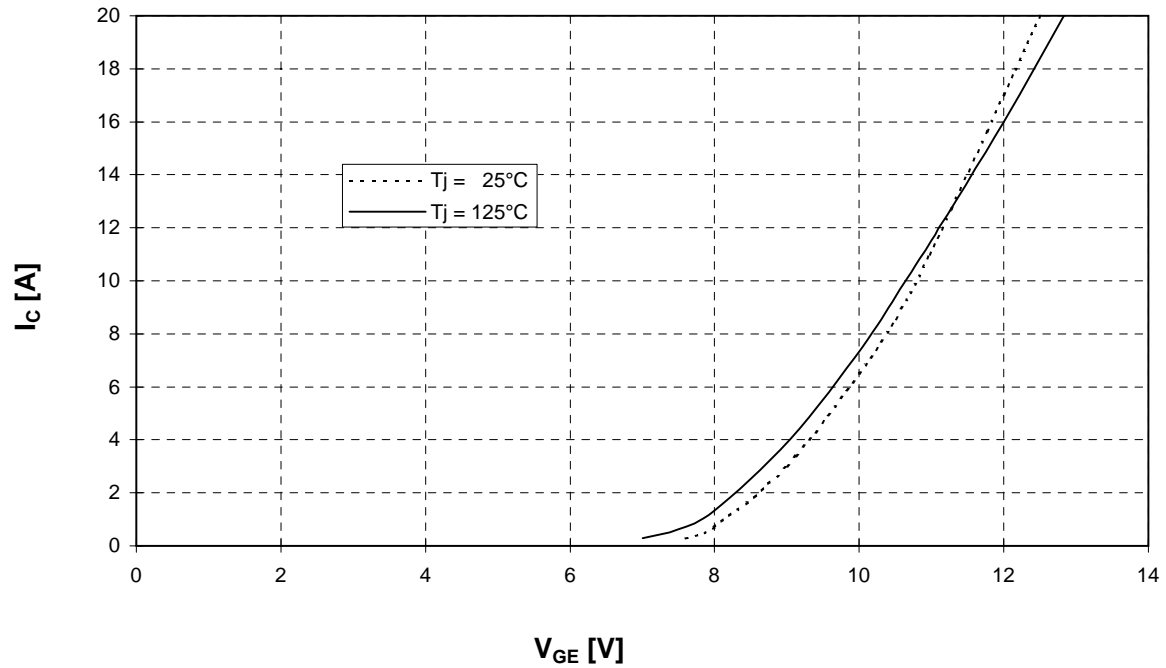

Durchlaßkennlinie der Freilaufdiode Wechselr. (typisch)

Forward characteristic of FWD Inverter (typical)

$i_F = f(V_F)$

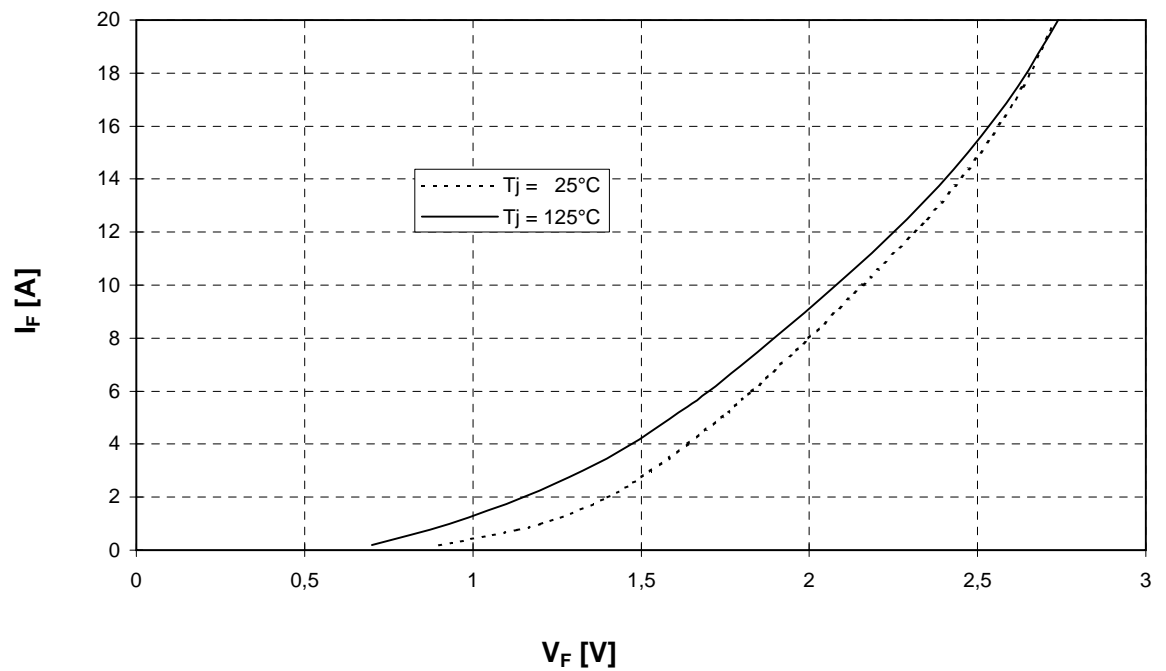

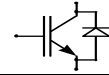

Schaltverluste Wechselr. (typisch) $E_{on} = f(I_C), E_{off} = f(I_C), E_{rec} = f(I_C)$ $V_{CC} = 600\text{ V}$
 Switching losses Inverter (typical) $T_j = 125^\circ\text{C}, V_{GE} = \pm 15\text{ V}, R_{Gon} = R_{Goff} = 82\text{ Ohm}$

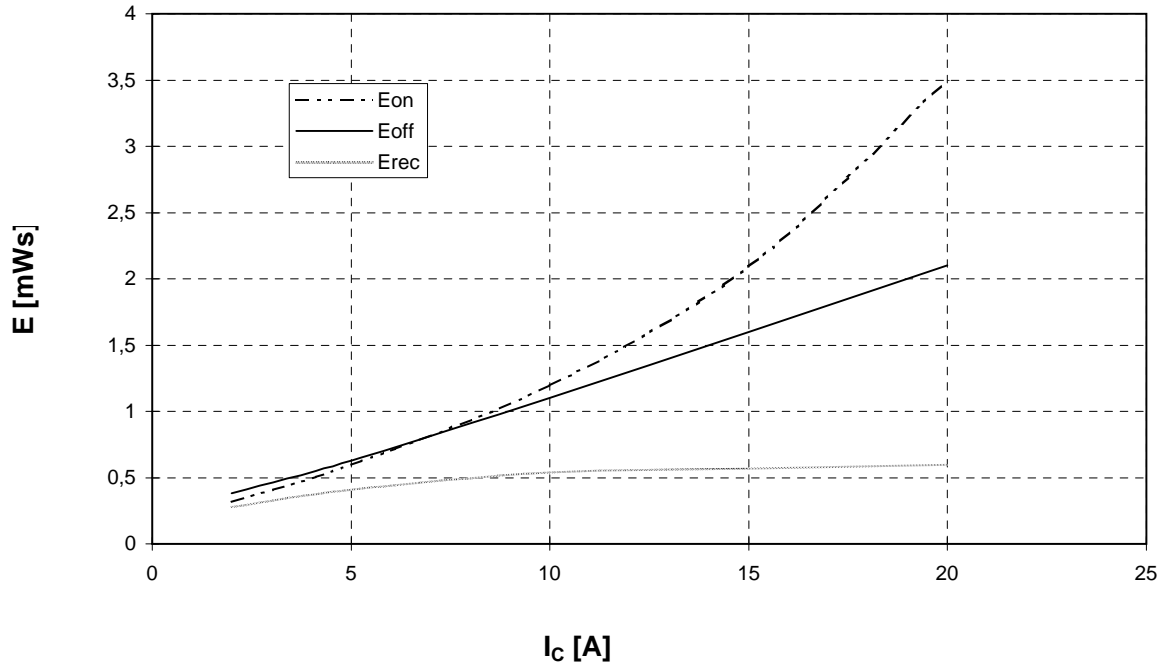

Schaltverluste Wechselr. (typisch) $E_{on} = f(R_G), E_{off} = f(R_G), E_{rec} = f(R_G)$
 Switching losses Inverter (typical) $T_j = 125^\circ\text{C}, V_{GE} = \pm 15\text{ V}, I_C = I_{nenn}, V_{CC} = 600\text{ V}$

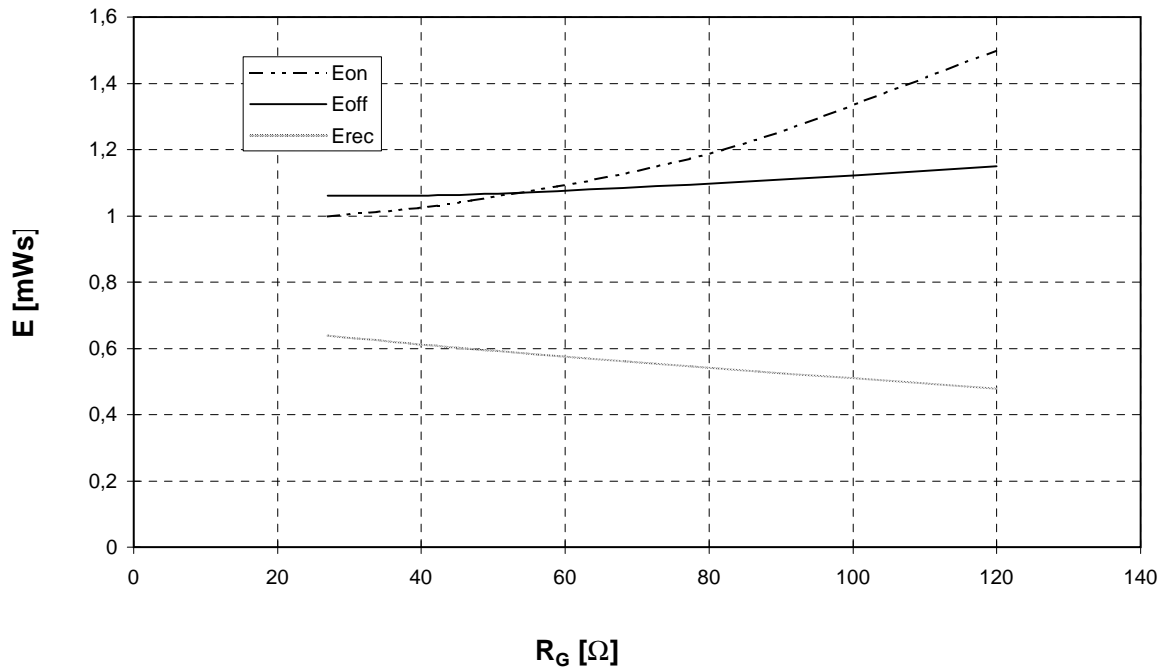

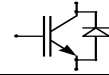

Transienter Wärmewiderstand Wechselr.
Transient thermal impedance Inverter

$$Z_{thJC} = f(t)$$

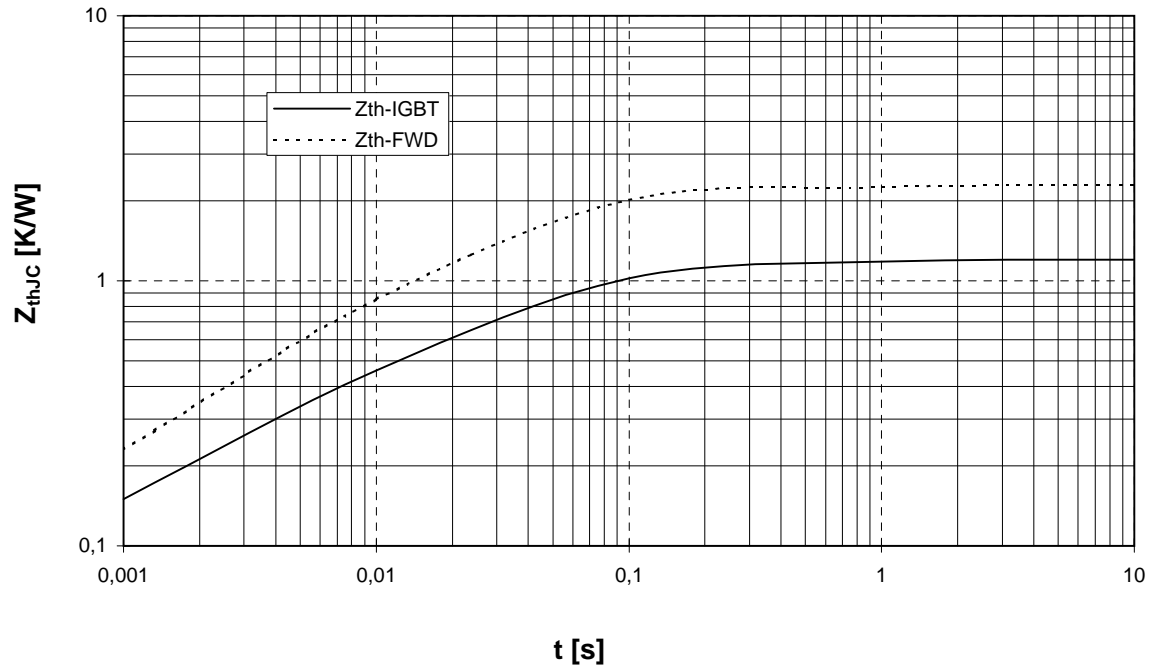

Sicherer Arbeitsbereich Wechselr. (RBSOA)

$$I_c = f(V_{CE})$$

Reverse bias safe operating area Inverter (RBSOA)_{T_{vj} = 125°C, V_{GE} = ±15V, R_G = 82 Ohm}

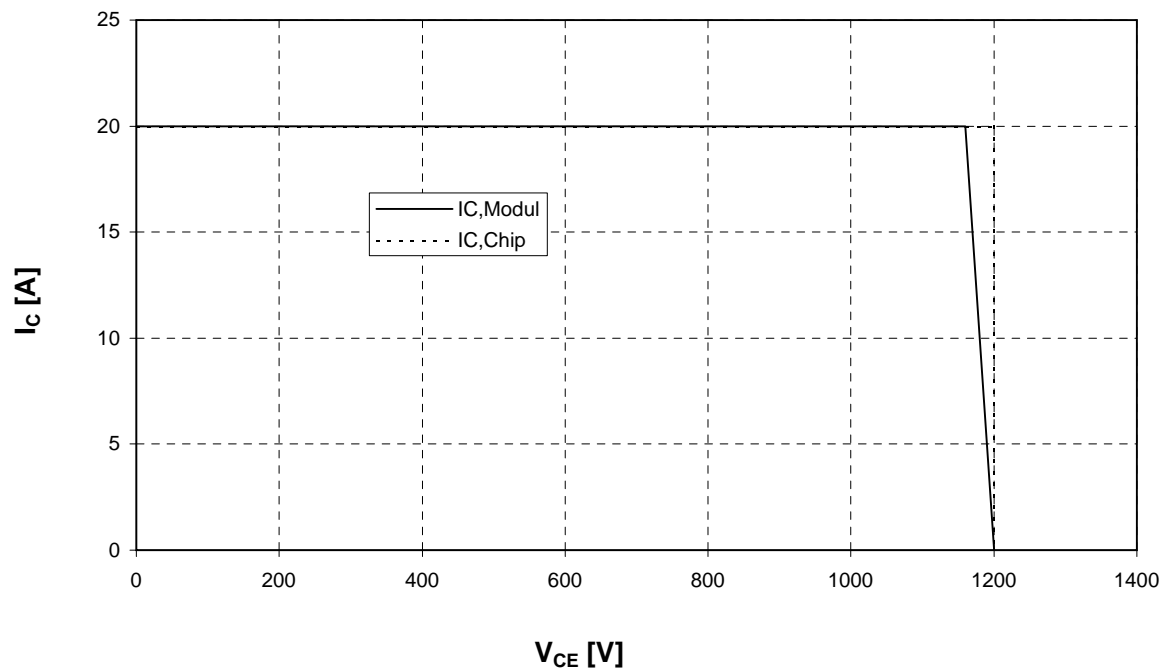

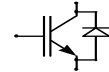

Ausgangskennlinienfeld Brems-Chopper-IGBT (typisch)

$d = f(V_{CE})$

Output characteristic brake-chopper-IGBT (typical)

$V_{GE} = 15\text{ V}$

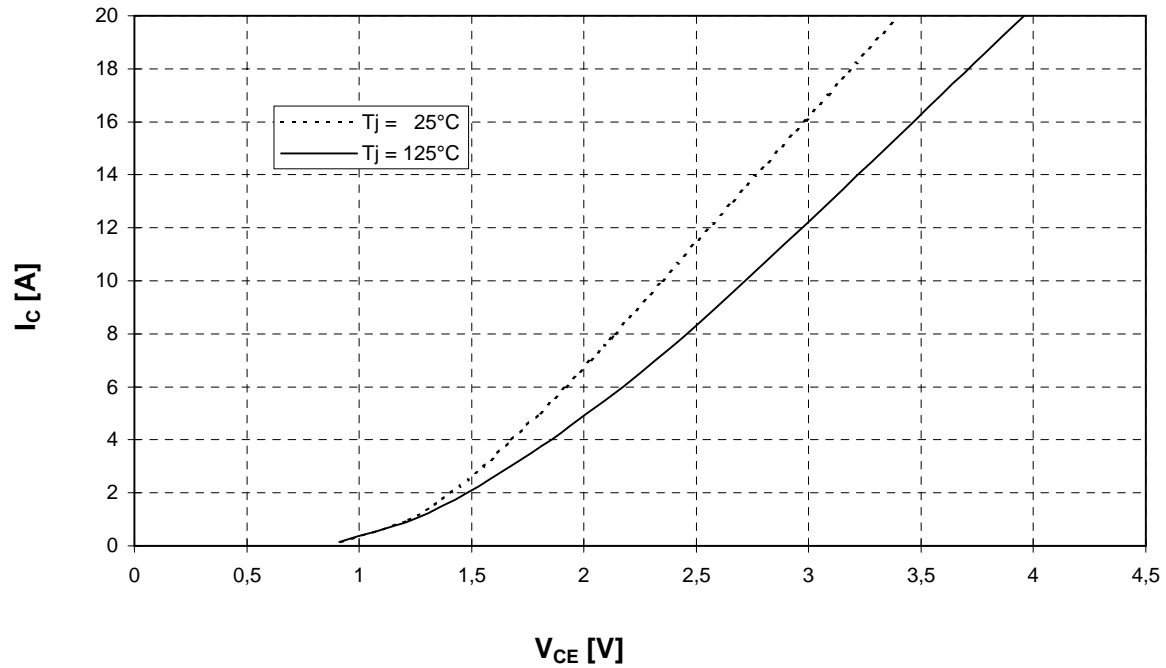

Durchlaßkennlinie der Brems-Chopper-Diode (typisch)

$i = f(V_F)$

Forward characteristic of brake-chopper-FWD (typical)

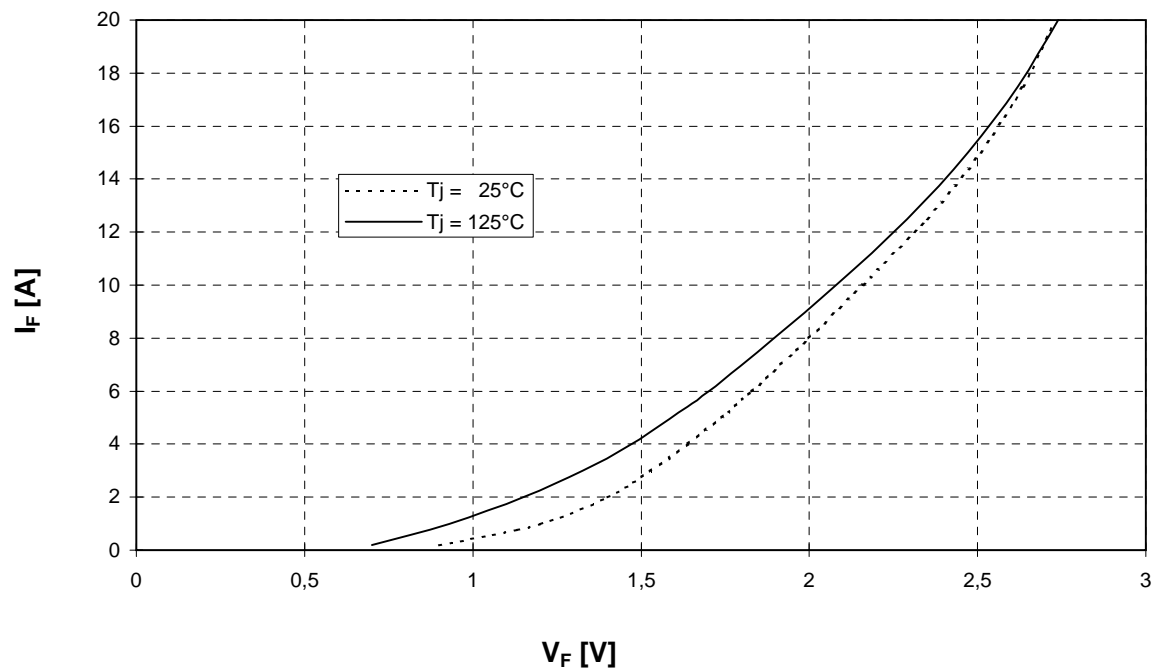

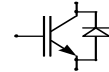

Durchlaßkennlinie der Gleichrichterdiode (typisch) $\mu = f(V_F)$
Forward characteristic of Rectifier Diode (typical)

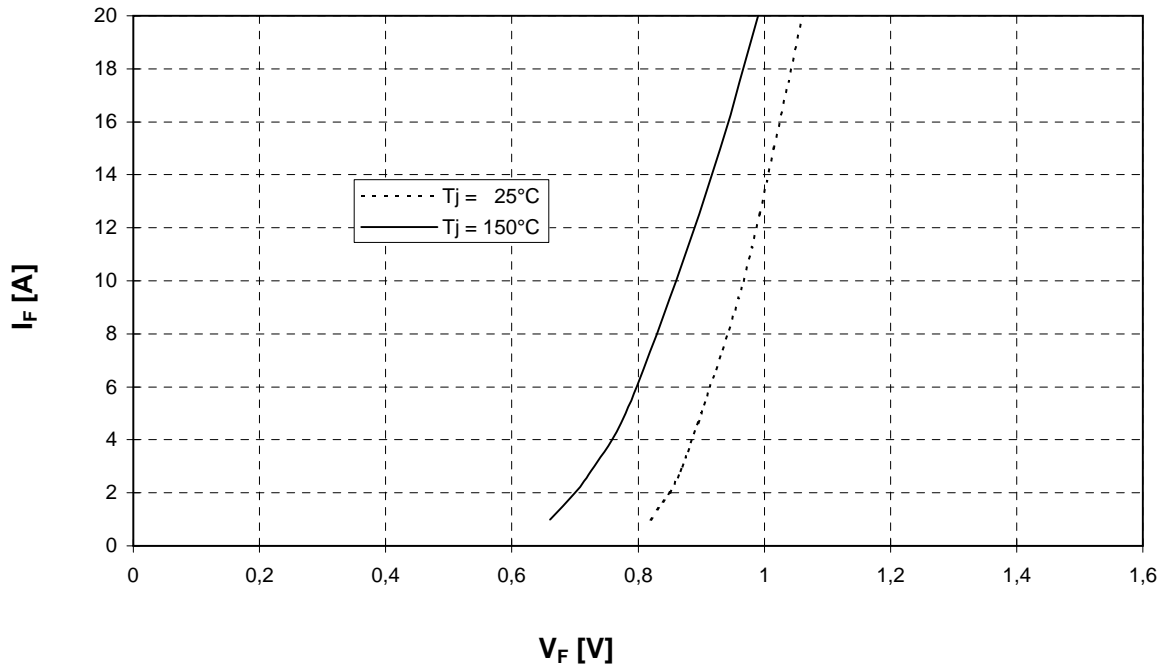

NTC- Temperaturkennlinie (typisch) $R = f(T)$
NTC- temperature characteristic (typical)

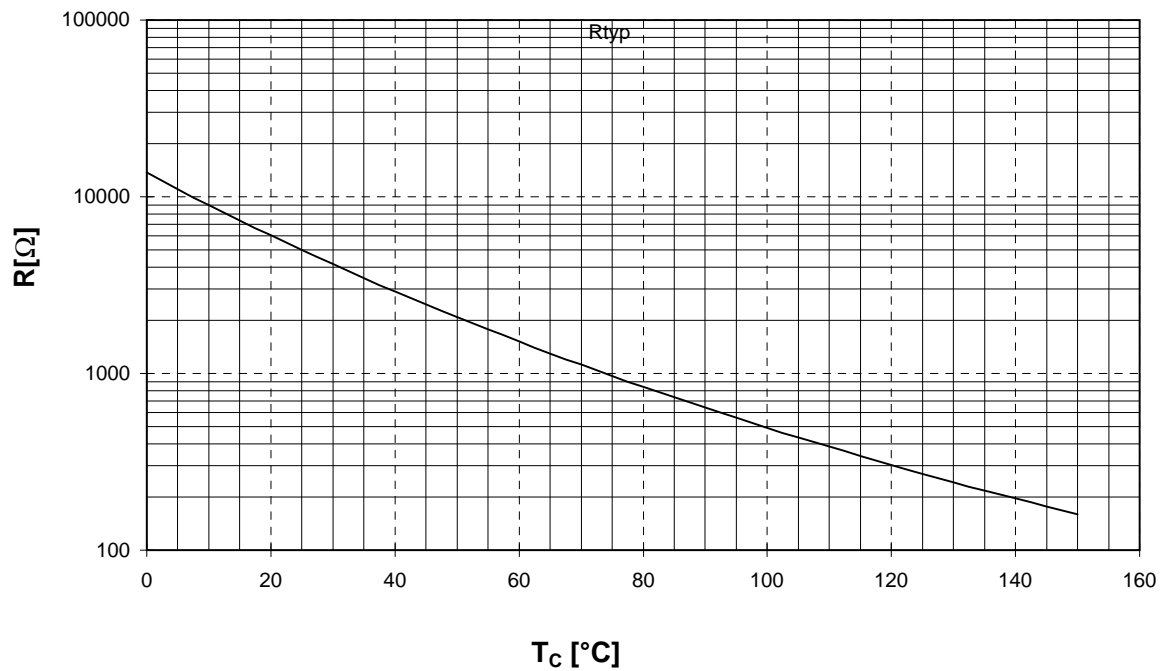

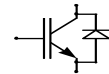

Schaltplan/ Circuit diagram

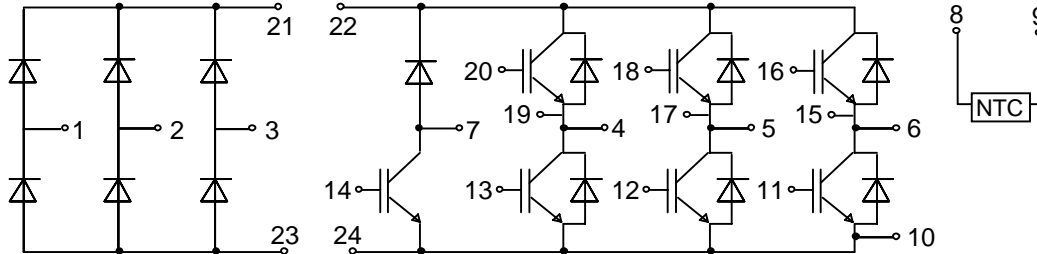

Gehäuseabmessungen/ Package outlines

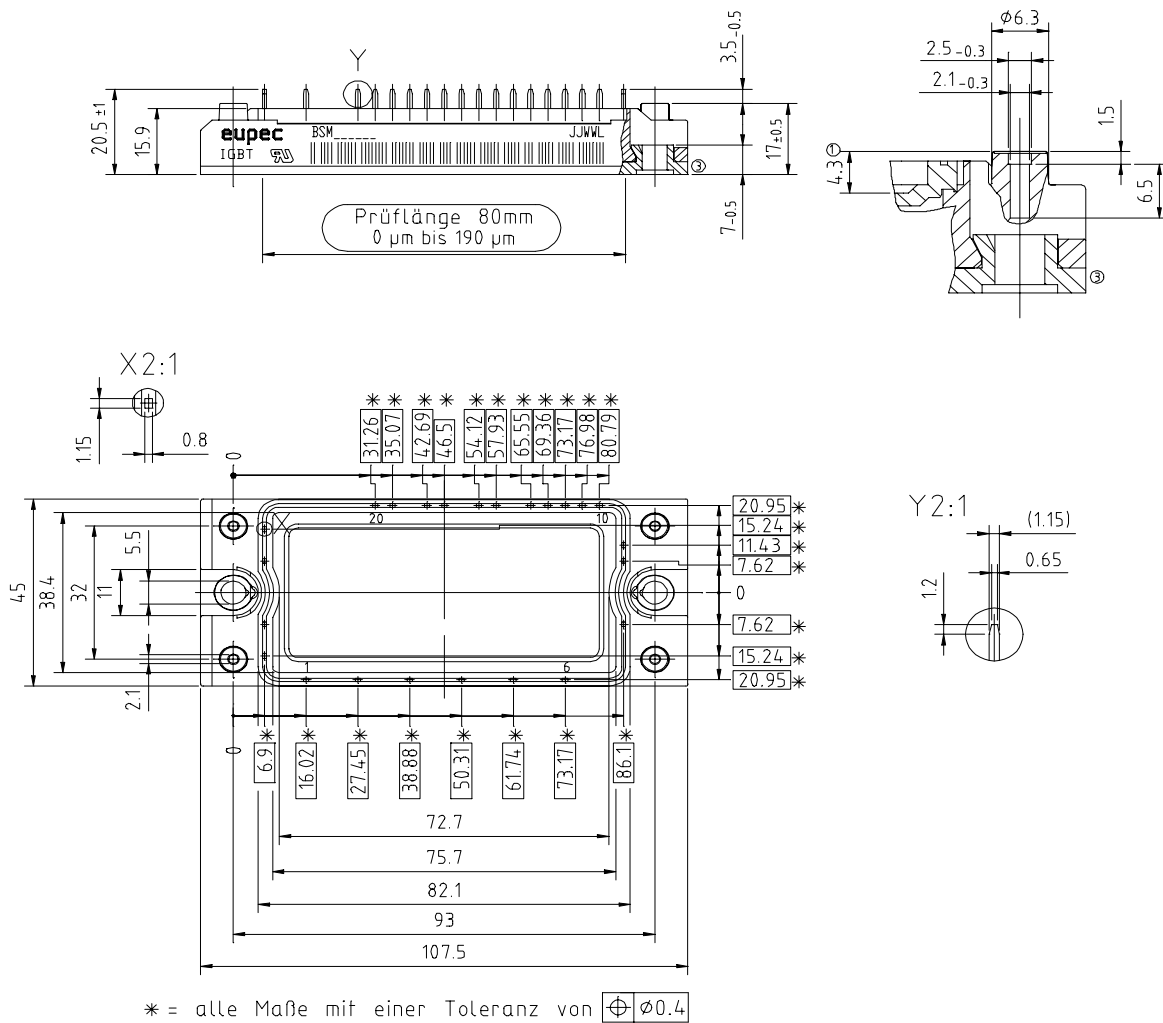

Mit dieser technischen Information werden Halbleiterbauelemente spezifiziert, jedoch keine Eigenschaften zugesichert. Sie gilt in Verbindung mit den zugehörigen Technischen Erläuterungen.

This technical information specifies semiconductor devices but promises no characteristics. It is valid in combination with the belonging technical notes.