

atrin **electronic**

Expertise, variety and quality



www.atrinelec.com

آترین الکترونیک

تخصص، تنوع و کیفیت

02166766957 - 02166766927



info@atrinelec.com



تهران پاساژ امجد طبقه 1 واحد 16



@atrinelec



Technical Data Sheet

Photocoupler-RoHS Compliant

EL817 Series

Features:

- Current transfer ratio
(CTR:MIN.50% at $I_F = 5\text{mA}$, $V_{CE} = 5\text{V}$)
- High isolation voltage between input and output (Viso=5000 V rms)
- Compact dual-in-line package
EL817*:1-channel type
- Pb free
- UL approved (No. E214129)
- VDE approved (No. 132249)
- SEMKO approved (No. 300858,300859,304855, 304827,2022251,0143133/01-03,0101083/01, 303345,303349)
- NEMKO approved (No. P04203585, P00102385, P02101854)
- DEMKO approved (No. 311822-01/02/03,310352-01, 311822-03A)
- CSA approved (No. 1143601)
- BSI approved (No. 8592, 8593)
- Options available:
 - Leads with 0.4”(10.16mm) spacing (M Type)
 - Leads bends for surface mounting (S and S1 Type)
 - Tape and Reel of Type I for SMD(Add”-TA” Suffix)
 - Tape and Reel of Type II for SMD(Add”-TB” Suffix)
 - The tape is 16mm and is wound on a 33cm reel
- The product itself will remain within RoHS compliant version.

**EL817****EL817M****EL817S**

Description

The EL817 series contains an infrared emitting diode optically coupled to a phototransistor. It is packaged in a 4-pin DIP package and available in wide-lead spacing and SMD option.

Applications

- Computer terminals
- System appliances, measuring instruments
- Registers, copiers, automatic vending machines
- Electric home appliances, such as fan heaters, etc.
- Signal transmission between circuits of different potentials and impedances

Technical Data Sheet

Photocoupler-RoHS Compliant

Device Selection Guide

Part. No.	Chip Material	
	IR	PT
EL817*	GaAs	Silicon

EL817 Series

Package Dimensions

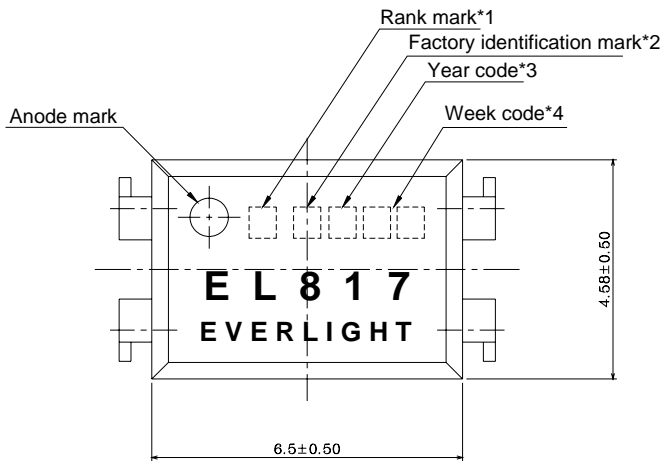

PIN NO. AND INTERNAL CONNECTION DIAGRAM

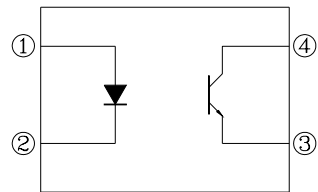

- 1. Anode
- 2. Cathode
- 3. Emitter
- 4. Collector

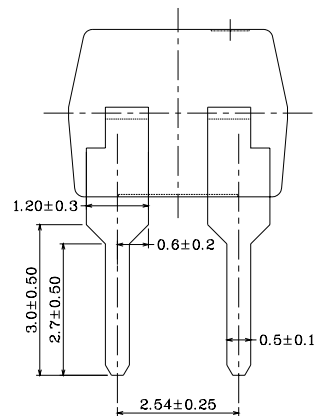
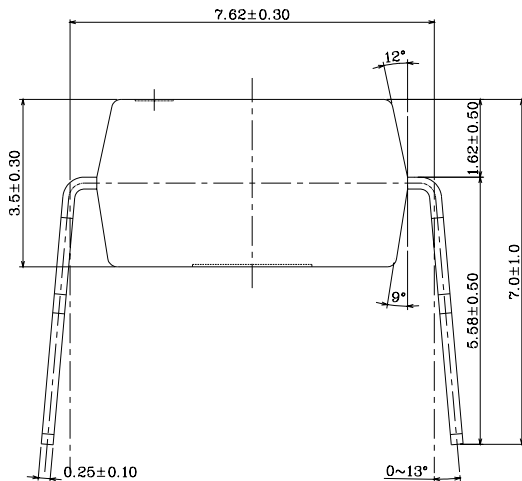

Technical Data Sheet
Photocoupler-RoHS Compliant

Package Dimensions

EL817 Series

M Type

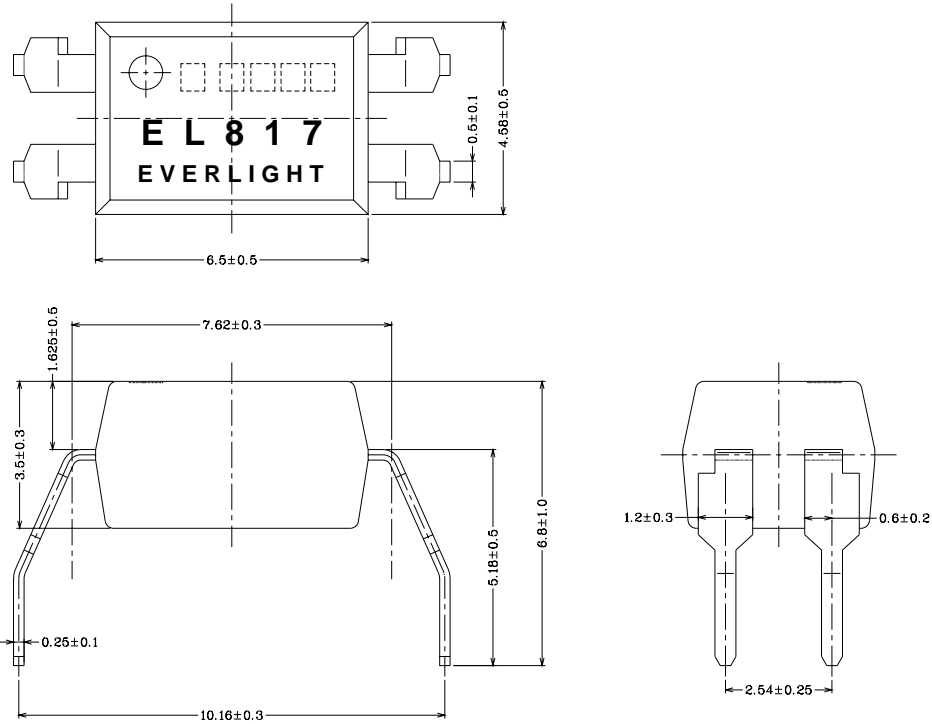

S Type

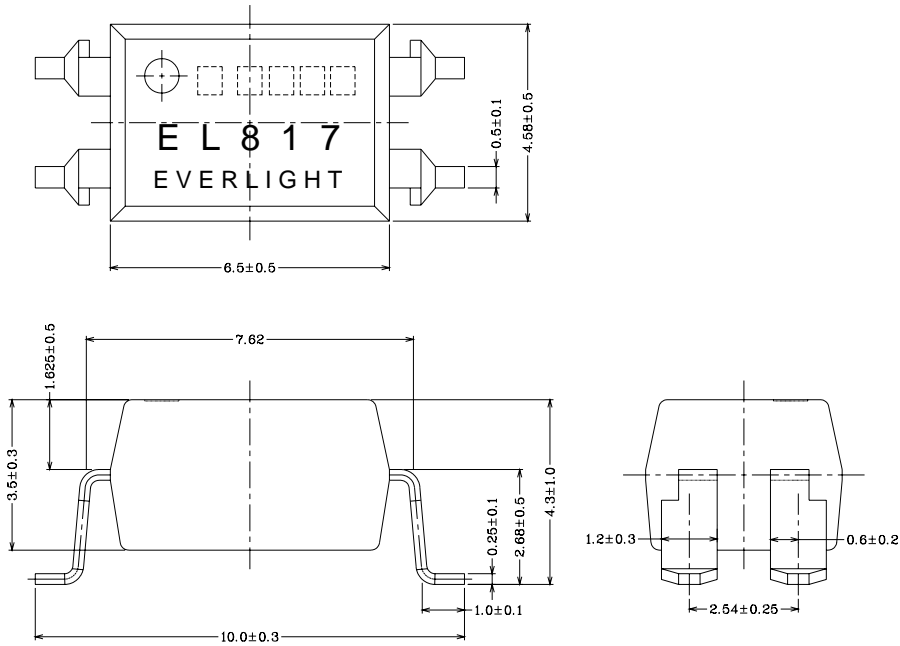

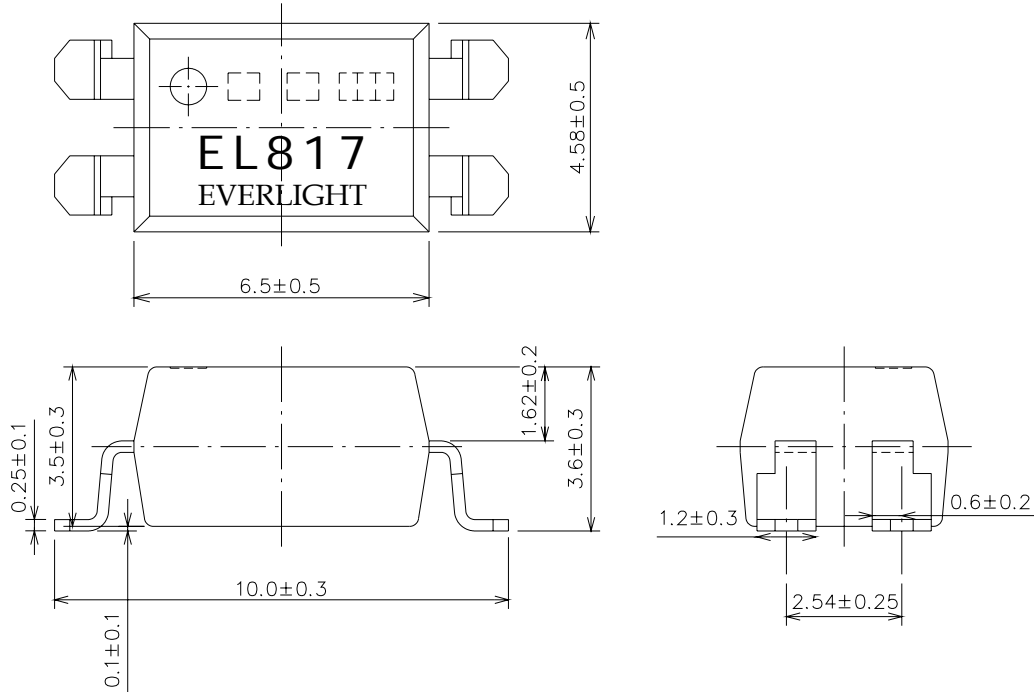
**Technical Data Sheet
Photocoupler-RoHS Compliant****EL817 Series****S1 Type****Notes:**

1. Rank shall be or shall not be marked
2. Factory code shall be marked (T: Taiwan / C: China)
3. Year date code
4. 2-digit work week
5. All dimensions are in millimeters
6. Specifications are subject to change without notice

**Technical Data Sheet
Photocoupler-RoHS Compliant**
EL817 Series
Absolute Maximum Ratings (Ta=25°C)

Parameter		Symbol	Rating	Unit
Input	Forward Current	I_F	50	mA
	Reverse Voltage	V_R	6	V
	Power Dissipation	P	70	mW
Output	Collector Power Dissipation	P_C	150	mW
	Collector Current	I_C	50	mA
	Collector-Emitter Voltage	V_{CEO}	35	V
	Emitter-Collector Voltage	V_{ECO}	6	V
Total Power Dissipation		P_{tot}	200	mW
* ¹ Isolation Voltage		Viso	5000	V rms
Operating Temperature		Topr	-55~+110	°C
Storage Temperature		Tstg	-55~+125	°C
* ² Soldering Temperature		Tsol	260	°C

*¹ AC for 1 minute, R.H= 40~ 60%RH

-Isolation voltage shall be measured using the following method.

- (1) Short between anode and cathode on the primary side and between collector, emitter and base on the secondary side.
- (2) The isolation voltage tester with zero-cross circuit shall be used.
- (3) The waveform of applied voltage shall be a sine wave

*² For 10 seconds

**Technical Data Sheet
Photocoupler-RoHS Compliant**
EL817 Series
Electro-Optical Characteristics

(Ta=25°C)

Parameter		Symbol	Min.	Typ.	Max.	Unit	Condition
Input	Forward	V_F	-	1.2	1.4	V	$I_F=20mA$
	Reverse Current	I_R	-	-	10	uA	$V_R=4V$
	Terminal	C_t	-	30	250	pF	$V=0, f=1kHz$
Output	Collector Dark current	I_{CEO}	-	-	100	nA	$V_{CE}=20V$
	Collector-Emitter breakdown voltage	BV_{CEO}	35	-	-	V	$I_c=0.1mA$
Transfer Characteristics	Current Transfer ratio	CTR	50	-	600	%	$I_F=5mA, V_{CE}=5V$
	Collector-Emitter saturation voltage	$V_{CE(sat)}$	-	0.1	0.2	V	$I_F=20mA, I_c=1mA$
	Isolation resistance	R_{ISO}	5×10^{10}	10^{11}	-	Ω	DC500V, 40~60% R.H
	Flotation capacitance	C_f	-	0.6	1.0	pF	$V=0, f=1MHz$
	Cut-off frequency	f_c	-	80	-	kHz	$V_{CE}=5V, I_c=2mA$ $R_L=100\Omega, -3dB$
	Rise time	t_r	-	4	18	us	$V_{CE}=2V$ $I_c=2mA, R_L=100\Omega$
	Fall time	t_f	-	3	18	us	

**Technical Data Sheet
Photocoupler-RoHS Compliant**
EL817 Series
Supplement
Current Transfer Ratio CTR

Sub-Model No.	Rank mark	CTR (%)	Condition
EL817* ^{note 1}		50 to 600	$I_F = 5 \text{ mA}$ $V_{CE} = 5 \text{ V}$ $T_a = 25^\circ\text{C}$
EL817* (L) ^{note2}	L	50 to 100	
EL817* (A)	A	80 to 160	
EL817* (B)	B	130 to 260	
EL817* (C)	C	200 to 400	
EL817* (D)	D	300 to 600	
EL817* (AB)	A or B	80 to 260	
EL817* (BC)	B or C	130 to 400	
EL817* (CD)	C or D	200 to 600	

Note1. The symbol “ * “ can be none or S or M by different leads form request

Note2. The symbol “ () ” can be CTR rank

Fig. 1 Forward Current vs.
Ambient Temperature

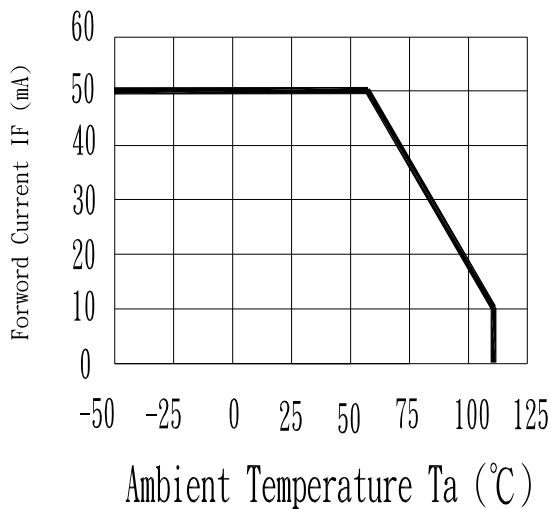
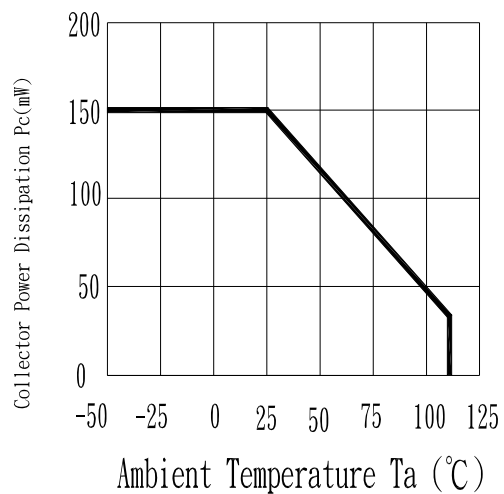

Fig.2 Collector Power Dissipation vs.
Ambient Temperature



**Technical Data Sheet
Photocoupler-RoHS Compliant**
EL817 Series

Fig. 3 Collector-emitter Saturation Voltage vs. Forward Current (Ta=25°C)

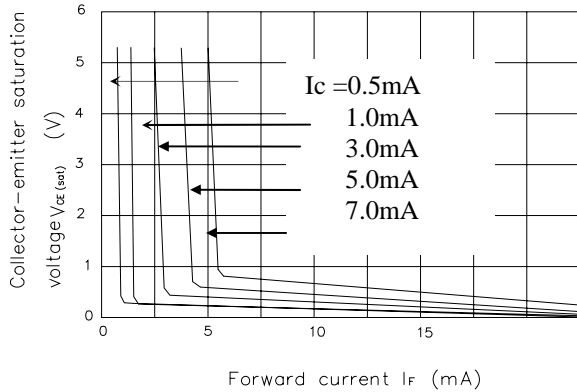

Fig.4 Current transfer Ratio vs. Forward Current

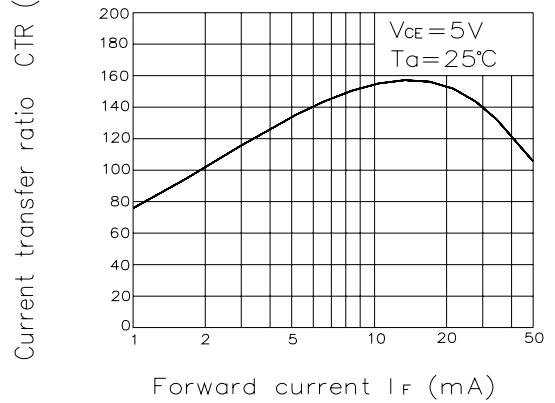

Fig.5 Forward Current vs. Forward Voltage

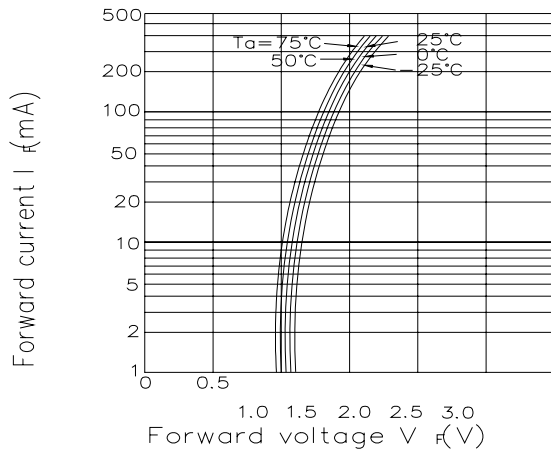

Fig.6 Collector Current vs. Collector-emitter Voltage (Ta=25°C)

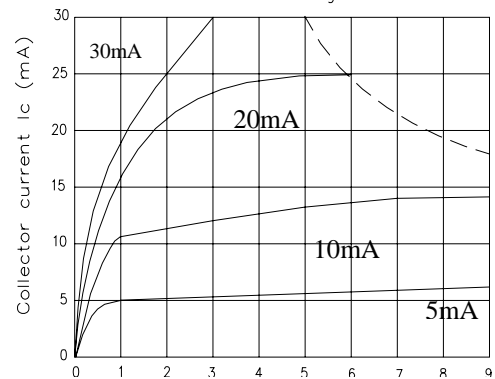

Fig.7 Relative Current Transfer Ratio vs. Ambient Temperature

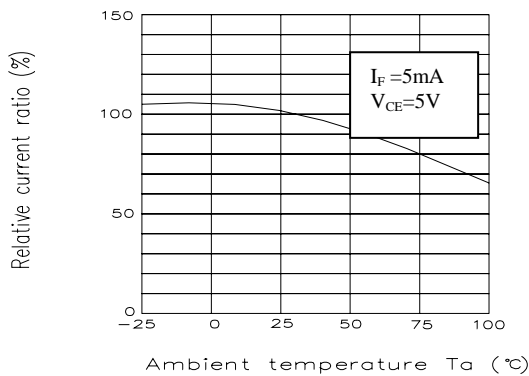
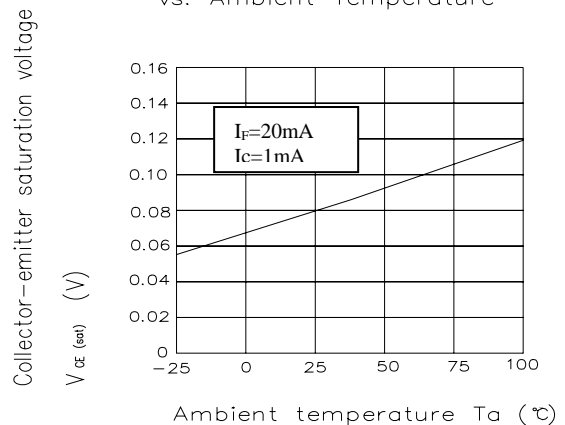

Fig.8 Collector-emitter Saturation Voltage vs. Ambient Temperature



Technical Data Sheet
Photocoupler-RoHS Compliant

EL817 Series

Fig.9 Collector Dark Current vs. Ambient Temperature

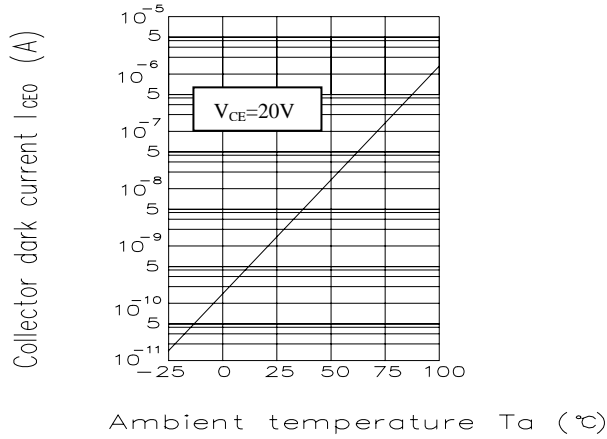

Fig.10 Response Time vs. Load Resistance

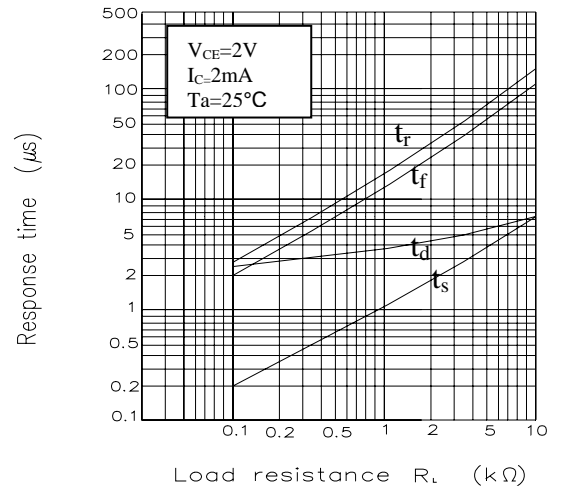
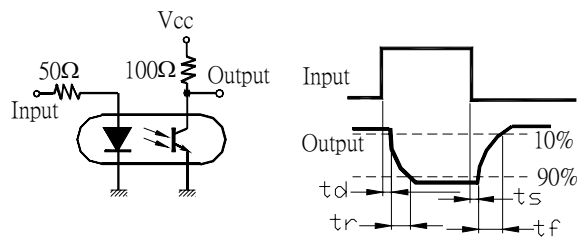
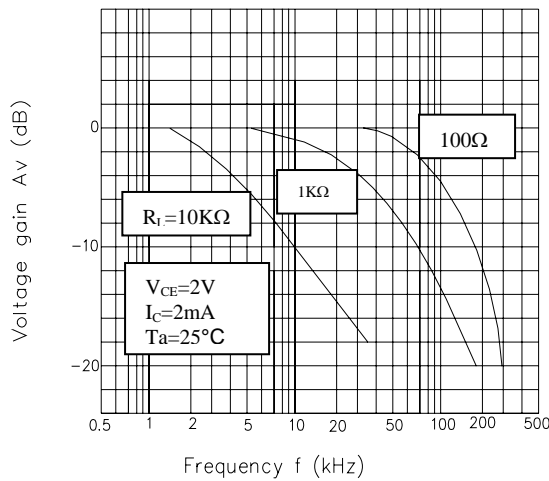

Fig.11 Frequency Response





Technical Data Sheet
Photocoupler-RoHS Compliant

RELIABILITY PLAN

EL817 Series

- The reliability of products shall be satisfied with items listed below.

Confidence level : 90 % , LTPD : 10 %

Classification	Test Item	Description & Condition	(Acc.) Sample	Failure Criteria	Reference Standard
Endurance test	Operation Life *	Ta = 25 ± 3°C IR: If = 50 mA Pt: Pc = 130 mW (Vf=1.4v) , 1000 hrs	0 / 22	CTR shift > 1.2 Vf > U* 1.0 Ir > U * 1.0 Vce(sat) > U*1.0 Bvceo < L*1.0 Bveco < L*1.0 L :Low Spec.Limit U : Up Spec.	MIL-S-750 : 1026 MIL-S-883 : 1005 JIS C 7021 : B-1
	High Temperature / High Humidity Reverse Bias (H3TRB)	Ta = 85 ± 3°C , Humi. = 85 % rh Pt: 80% * Vce (max rating) , 1000 hrs	0 / 22		JIS C 7021 : B-11
	High Temperature Reverse Bias (HTRB)	Ta = 105 ± 3°C Pt: 100% * Vce (Max rating) , 1000 hrs	0 / 22		JIS C 7021 : B-8
	Low Temperature Storage	Ta = -50 ± 3°C , 1000 hrs	0 / 22		JIS C 7021 : B-12
	High Temperature Storage	Ta = 125 ± 3°C , 1000 hrs	0 / 22		JIS C 7021 : B-10 MIL-S-883 : 1008
	Auto clamp	P = 15 PSIG , Ta = 121 °C , Humi. = 100 % rh , 48 hrs	0 / 22		JESD 22-A102-B
Environmental Test	Temperature Cycling (Air to Air)	125°C ~ -55°C 30 ~ 30 min , 100 cycles	0 / 22	Limit	MIL-S-883 :1010 JIS C 7021 : A-4
	Thermal Shock (Liquid to Liquid)	125 ~ -55°C t (dwell) = 5 min t (trans.) = 10 sec , 100 cycles	0 / 22		MIL-S-202 : 107D MIL-S-750 : 1051 MIL-S-883 :1011
	Solder Resistance	Ta = 260 ± 3°C t (dwell) = 10 ± 1 sec	0 / 22		MIL-S-750 : 2031 JIS C 7021 : A-1
	Solder Ability	Ta = 230 ± 3 °C t (dwell) = 5 ± 1 sec	0 / 22		MIL-S-883 : 2003 JIS C 7021 : A-2

Technical Data Sheet
Photocoupler-RoHS Compliant

EL817 Series

1. Tube Packing Specifications (For Dip & M Type)

1. Tube

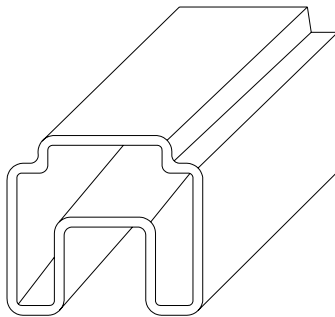

2. Inner Carton

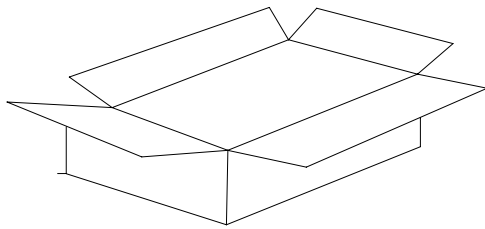

3. Outside Carton

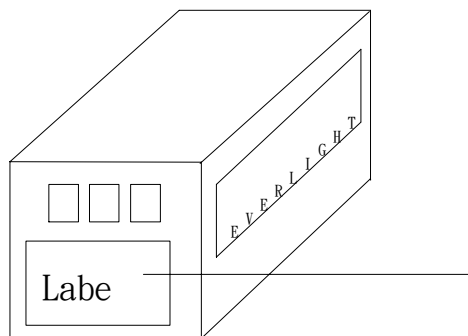

EVERLIGHT

CPN:

P/N:



EL817

QTY:



LOT NO:

MADE IN TAIWAN



● Packing Quantity

- 1. 100 Pcs/ Per Tube
- 2. 25 Tubes / Inner Carton
- 3. 12 Inner Cartons / Outside Carton

**Technical Data Sheet
Photocoupler-RoHS Compliant**

EL817 Series

1. Tape & Reel Packing Specifications

1. Tape & Reel (For S & S1 Type only)

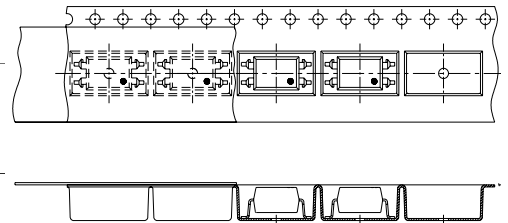
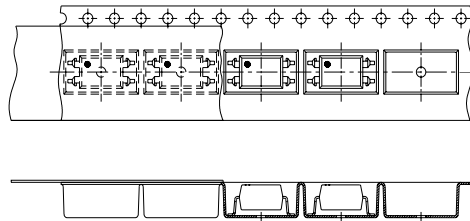
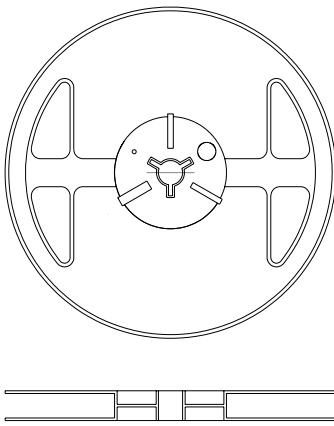

TA

TB

2. Inner Carton

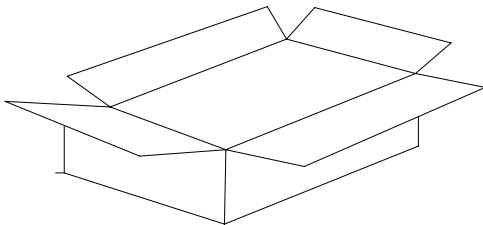

3. Outside Carton

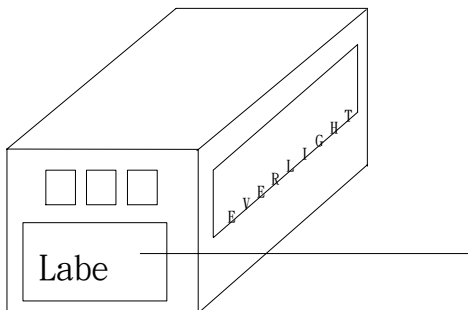

EVERLIGHT

CPN:

P/N:

EL817

QTY:

LOT NO:



RoHS

CAT:

HUE:

REF:

MADE IN TAIWAN



● Packing Quantity

1. 1,000 Pcs / Per Reel
2. 3 Reels / Inner Carton



Technical Data Sheet
Photocoupler-RoHS Compliant

3. 10 Inner Cartons / Outside Carton

EL817 Series