

**atrin** **electronic**

Expertise, variety and quality



www.atrinelec.com

**آترین الکترونیک**

تخصص، تنوع و کیفیت

۰۲۱۶۶۷۰۳۶۵۲



Info@Atrinelec.com



تهران، پاساژ امجد، طبقه اول، واحد ۱۶



@ATRINELEC



# STARPOWER

SEMICONDUCTOR

**IGBT**

## GD150HFF120C2S

**1200V/150A 2 in one-package**

### General Description

STARPOWER IGBT Power Module provides ultra switching speed as well as short circuit ruggedness. They are designed for the applications such as electronic welder and inductive heating.

### Features

- Low  $V_{CE(sat)}$  Trench IGBT technology
- $V_{CE(sat)}$  with positive temperature coefficient
- Low switching losses
- Maximum junction temperature 175°C
- Low inductance case
- Fast & soft reverse recovery anti-parallel FWD
- Isolated copper baseplate using DBC technology



### Typical Applications

- Switching mode power supply
- Inductive heating
- Electronic welder

### Equivalent Circuit Schematic

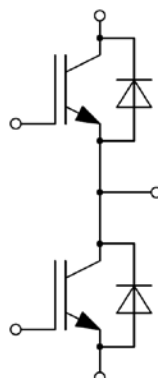

**Absolute Maximum Ratings**  $T_C=25^{\circ}\text{C}$  unless otherwise noted**IGBT**

Symbol	Description	Value	Unit
$V_{CES}$	Collector-Emitter Voltage	1200	V
$V_{GES}$	Gate-Emitter Voltage	$\pm 20$	V
$I_C$	Collector Current @ $T_C=25^{\circ}\text{C}$	209	A
	@ $T_C=80^{\circ}\text{C}$	150	
$I_{CM}$	Pulsed Collector Current $t_p=1\text{ms}$	300	A
$P_D$	Maximum Power Dissipation @ $T_j=175^{\circ}\text{C}$	833	W

**Diode**

Symbol	Description	Value	Unit
$V_{RRM}$	Repetitive Peak Reverse Voltage	1200	V
$I_F$	Diode Continuous Forward Current	150	A
$I_{FM}$	Diode Maximum Forward Current $t_p=1\text{ms}$	300	A

**Module**

Symbol	Description	Value	Unit
$T_{jmax}$	Maximum Junction Temperature	175	$^{\circ}\text{C}$
$T_{jop}$	Operating Junction Temperature	-40 to +150	$^{\circ}\text{C}$
$T_{STG}$	Storage Temperature Range	-40 to +125	$^{\circ}\text{C}$
$V_{ISO}$	Isolation Voltage RMS, $f=50\text{Hz}$ , $t=1\text{min}$	4000	V

**IGBT Characteristics**  $T_c=25^\circ\text{C}$  unless otherwise noted

Symbol	Parameter	Test Conditions	Min.	Typ.	Max.	Unit	
$V_{CE(sat)}$	Collector to Emitter Saturation Voltage	$I_C=150\text{A}, V_{GE}=15\text{V}, T_j=25^\circ\text{C}$		2.05	2.50	V	
		$I_C=150\text{A}, V_{GE}=15\text{V}, T_j=125^\circ\text{C}$		2.55			
		$I_C=150\text{A}, V_{GE}=15\text{V}, T_j=150^\circ\text{C}$		2.70			
$V_{GE(th)}$	Gate-Emitter Threshold Voltage	$I_C=3.76\text{mA}, V_{CE}=V_{GE}, T_j=25^\circ\text{C}$	5.2	6.0	6.8	V	
$I_{CES}$	Collector Cut-Off Current	$V_{CE}=V_{CES}, V_{GE}=0\text{V}, T_j=25^\circ\text{C}$			1.0	mA	
$I_{GES}$	Gate-Emitter Leakage Current	$V_{GE}=V_{GES}, V_{CE}=0\text{V}, T_j=25^\circ\text{C}$			100	nA	
$R_{Gint}$	Internal Gate Resistance			2.5		$\Omega$	
$t_{d(on)}$	Turn-On Delay Time	$V_{CC}=600\text{V}, I_C=150\text{A}, R_G=1.1\Omega, V_{GE}=\pm 15\text{V}, T_j=25^\circ\text{C}$		200		ns	
$t_r$	Rise Time			28		ns	
$t_{d(off)}$	Turn-Off Delay Time			210		ns	
$t_f$	Fall Time			209		ns	
$E_{on}$	Turn-On Switching Loss				5.46		mJ
$E_{off}$	Turn-Off Switching Loss				8.40		mJ
$t_{d(on)}$	Turn-On Delay Time	$V_{CC}=600\text{V}, I_C=150\text{A}, R_G=1.1\Omega, V_{GE}=\pm 15\text{V}, T_j=125^\circ\text{C}$		219		ns	
$t_r$	Rise Time			33		ns	
$t_{d(off)}$	Turn-Off Delay Time			235		ns	
$t_f$	Fall Time			225		ns	
$E_{on}$	Turn-On Switching Loss				10.7		mJ
$E_{off}$	Turn-Off Switching Loss				8.94		mJ
$t_{d(on)}$	Turn-On Delay Time	$V_{CC}=600\text{V}, I_C=150\text{A}, R_G=1.1\Omega, V_{GE}=\pm 15\text{V}, T_j=150^\circ\text{C}$		233		ns	
$t_r$	Rise Time			31		ns	
$t_{d(off)}$	Turn-Off Delay Time			319		ns	
$t_f$	Fall Time			153		ns	
$E_{on}$	Turn-On Switching Loss				11.5		mJ
$E_{off}$	Turn-Off Switching Loss				11.5		mJ

**Diode Characteristics**  $T_C=25^{\circ}\text{C}$  unless otherwise noted

Symbol	Parameter	Test Conditions	Min.	Typ.	Max.	Unit
$V_F$	Diode Forward Voltage	$I_F=150\text{A}, V_{GE}=0\text{V}, T_j=25^{\circ}\text{C}$		2.15	2.60	V
		$I_F=150\text{A}, V_{GE}=0\text{V}, T_j=125^{\circ}\text{C}$		2.15		
		$I_F=150\text{A}, V_{GE}=0\text{V}, T_j=150^{\circ}\text{C}$		2.15		
$Q_r$	Recovered Charge	$V_R=600\text{V}, I_F=150\text{A},$ $-di/dt=4600\text{A}/\mu\text{s}, V_{GE}=-15\text{V}$ $T_j=25^{\circ}\text{C}$		12.0		$\mu\text{C}$
$I_{RM}$	Peak Reverse Recovery Current			148		A
$E_{rec}$	Reverse Recovery Energy			5.34		mJ
$Q_r$	Recovered Charge	$V_R=600\text{V}, I_F=150\text{A},$ $-di/dt=4600\text{A}/\mu\text{s}, V_{GE}=-15\text{V}$ $T_j=125^{\circ}\text{C}$		18.8		$\mu\text{C}$
$I_{RM}$	Peak Reverse Recovery Current			140		A
$E_{rec}$	Reverse Recovery Energy			7.22		mJ
$Q_r$	Recovered Charge	$V_R=600\text{V}, I_F=150\text{A},$ $-di/dt=4600\text{A}/\mu\text{s}, V_{GE}=-15\text{V}$ $T_j=150^{\circ}\text{C}$		19.2		$\mu\text{C}$
$I_{RM}$	Peak Reverse Recovery Current			126		A
$E_{rec}$	Reverse Recovery Energy			7.48		mJ

**Module Characteristics**  $T_C=25^{\circ}\text{C}$  unless otherwise noted

Symbol	Parameter	Min.	Typ.	Max.	Unit
$L_{CE}$	Stray Inductance		15		nH
$R_{CC'+EE'}$	Module Lead Resistance, Terminal to Chip		0.25		m $\Omega$
$R_{thJC}$	Junction-to-Case (per IGBT)			0.180	K/W
	Junction-to-Case (per Diode)			0.265	
$R_{thCH}$	Case-to-Heatsink (per IGBT)		0.034		K/W
	Case-to-Heatsink (per Diode)		0.049		
	Case-to-Heatsink (per Module)		0.010		
M	Terminal Connection Torque, Screw M6	2.5		5.0	N.m
	Mounting Torque, Screw M6	3.0		5.0	
G	Weight of Module		300		g

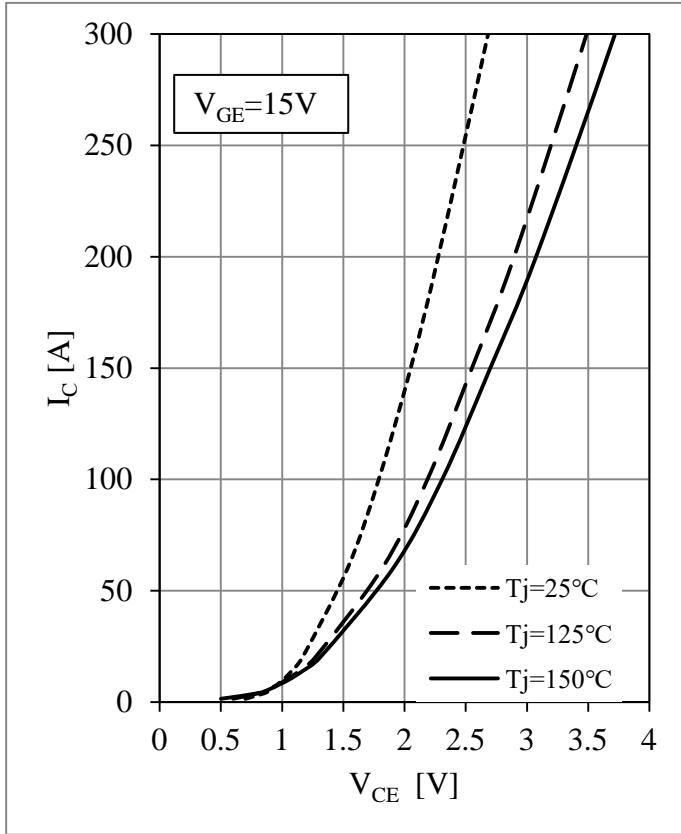

Fig 1. IGBT Output Characteristics

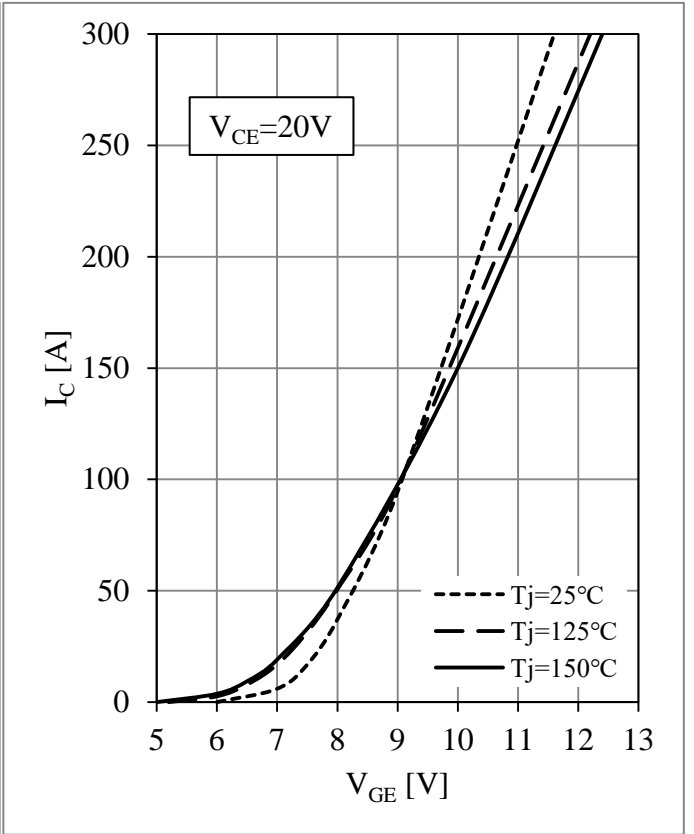

Fig 2. IGBT Transfer Characteristics

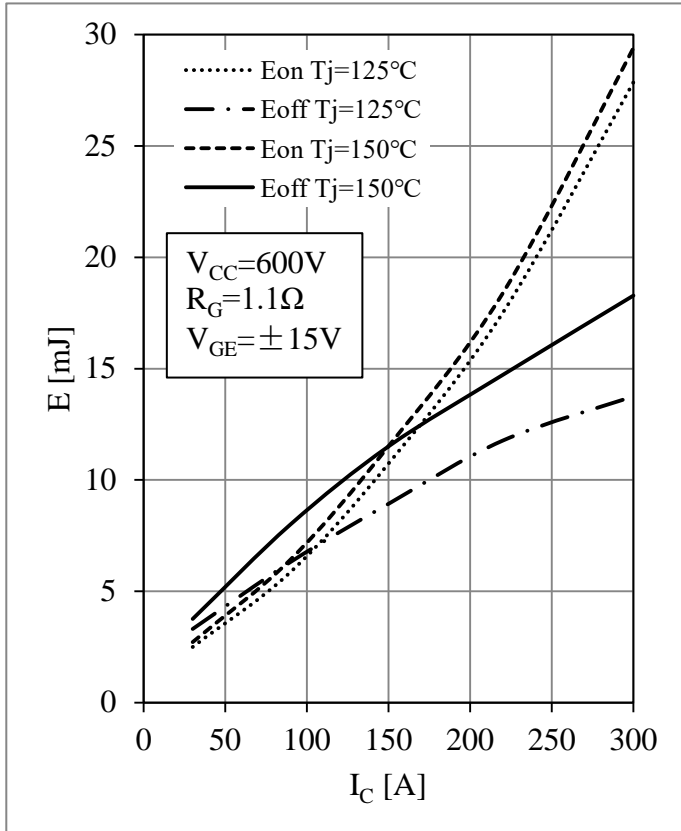

Fig 3. IGBT Switching Loss vs.  $I_C$

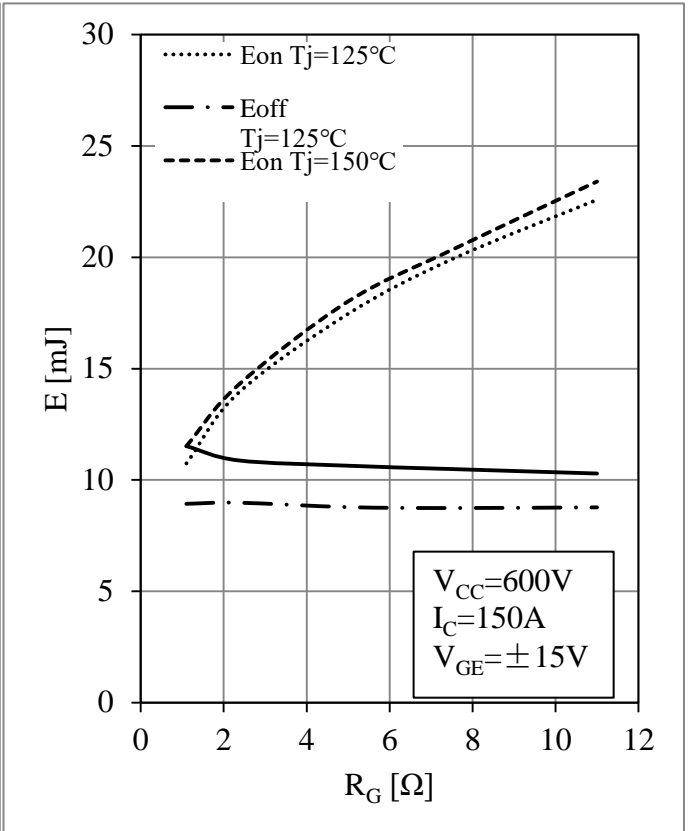

Fig 4. IGBT Switching Loss vs.  $R_G$

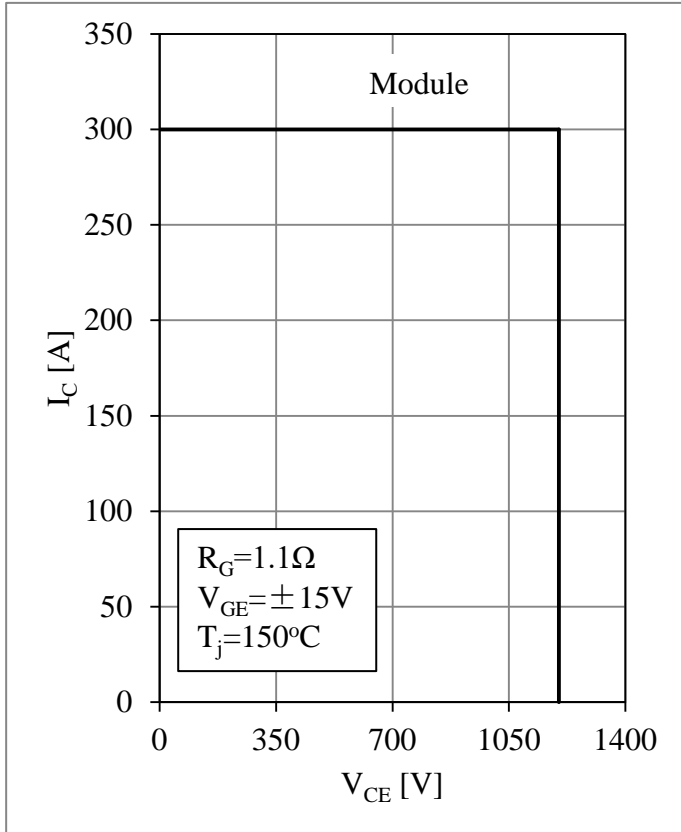

Fig 5. RBSOA

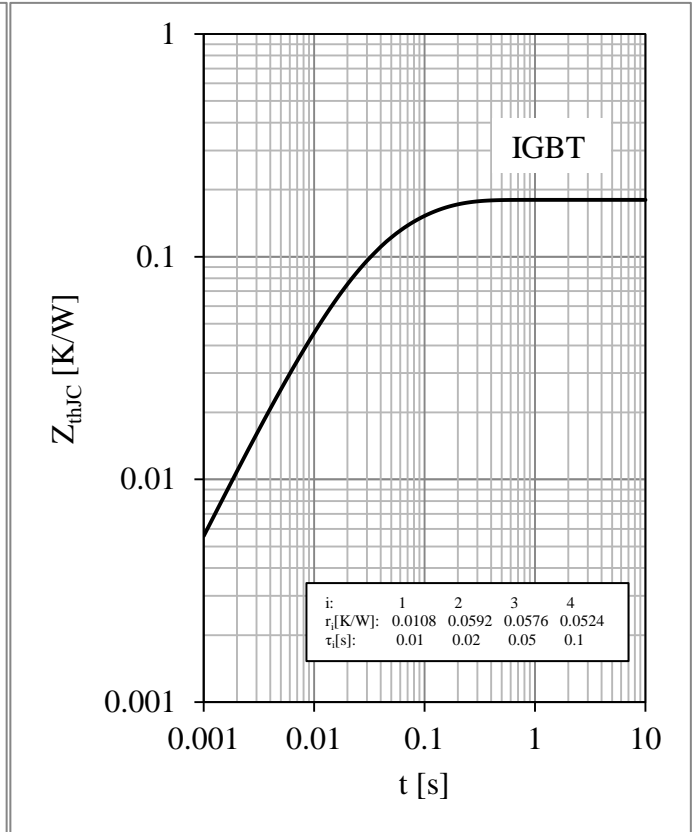

Fig 6. IGBT Transient Thermal Impedance

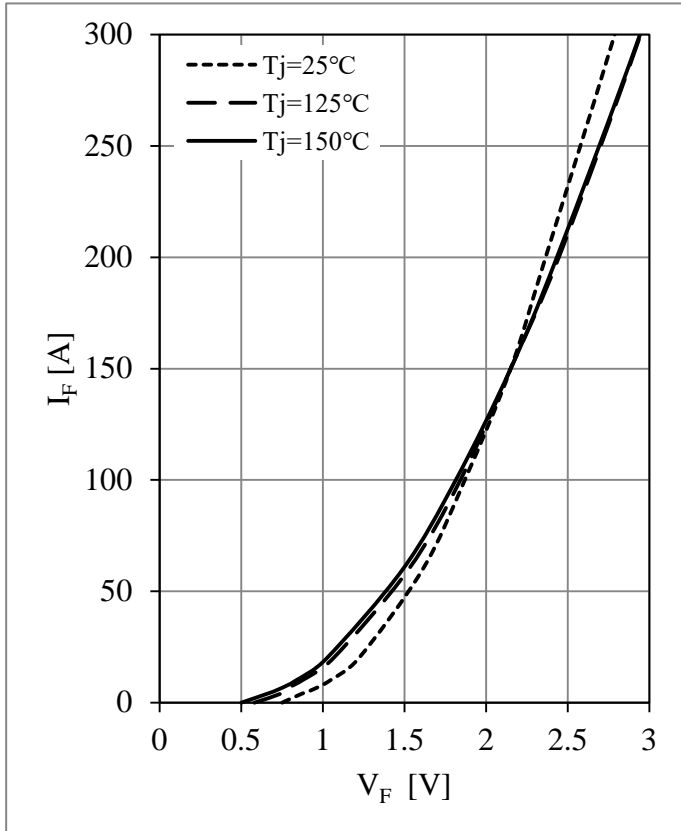

Fig 7. Diode Forward Characteristics

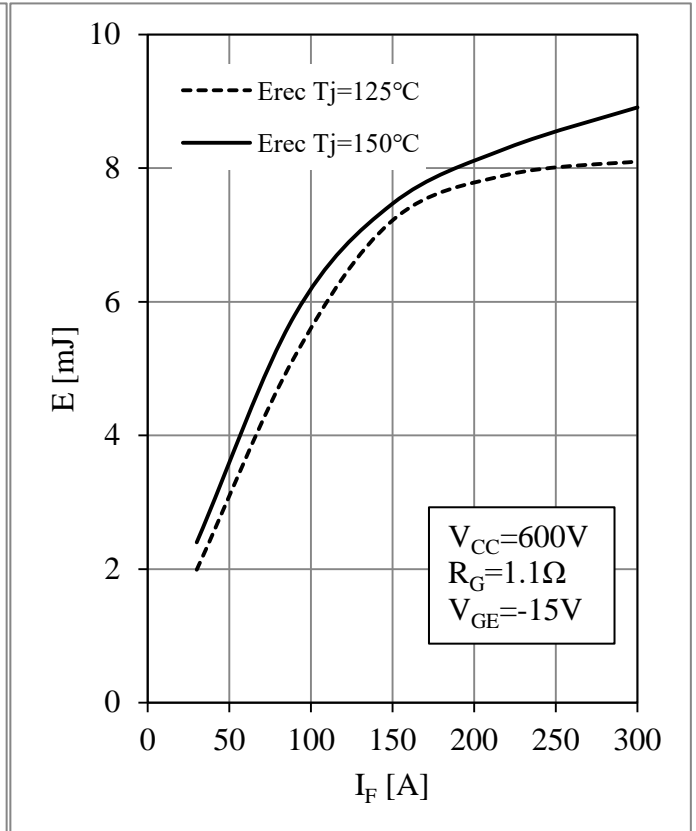

Fig 8. Diode Switching Loss vs.  $I_F$

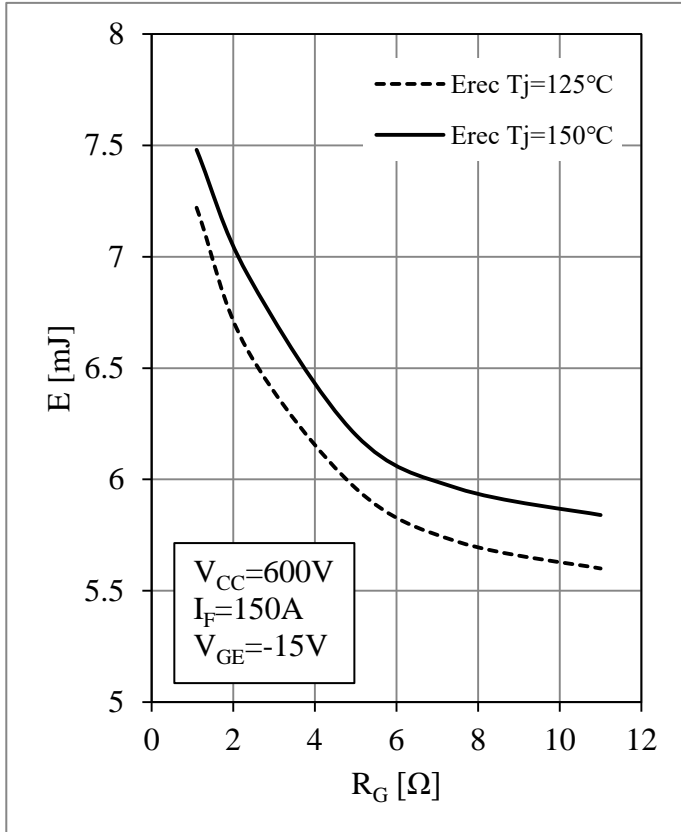

Fig 9. Diode Switching Loss vs.  $R_G$

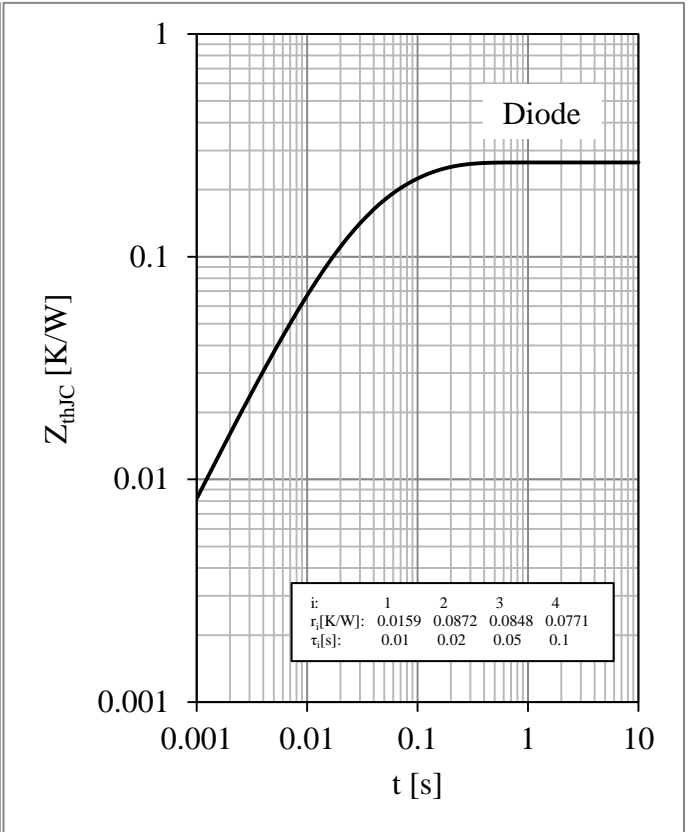
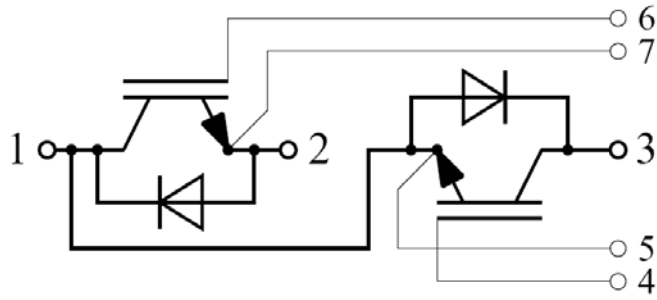

Fig 10. Diode Transient Thermal Impedance



**Circuit Schematic**



**Package Dimensions**

Dimensions in Millimeters

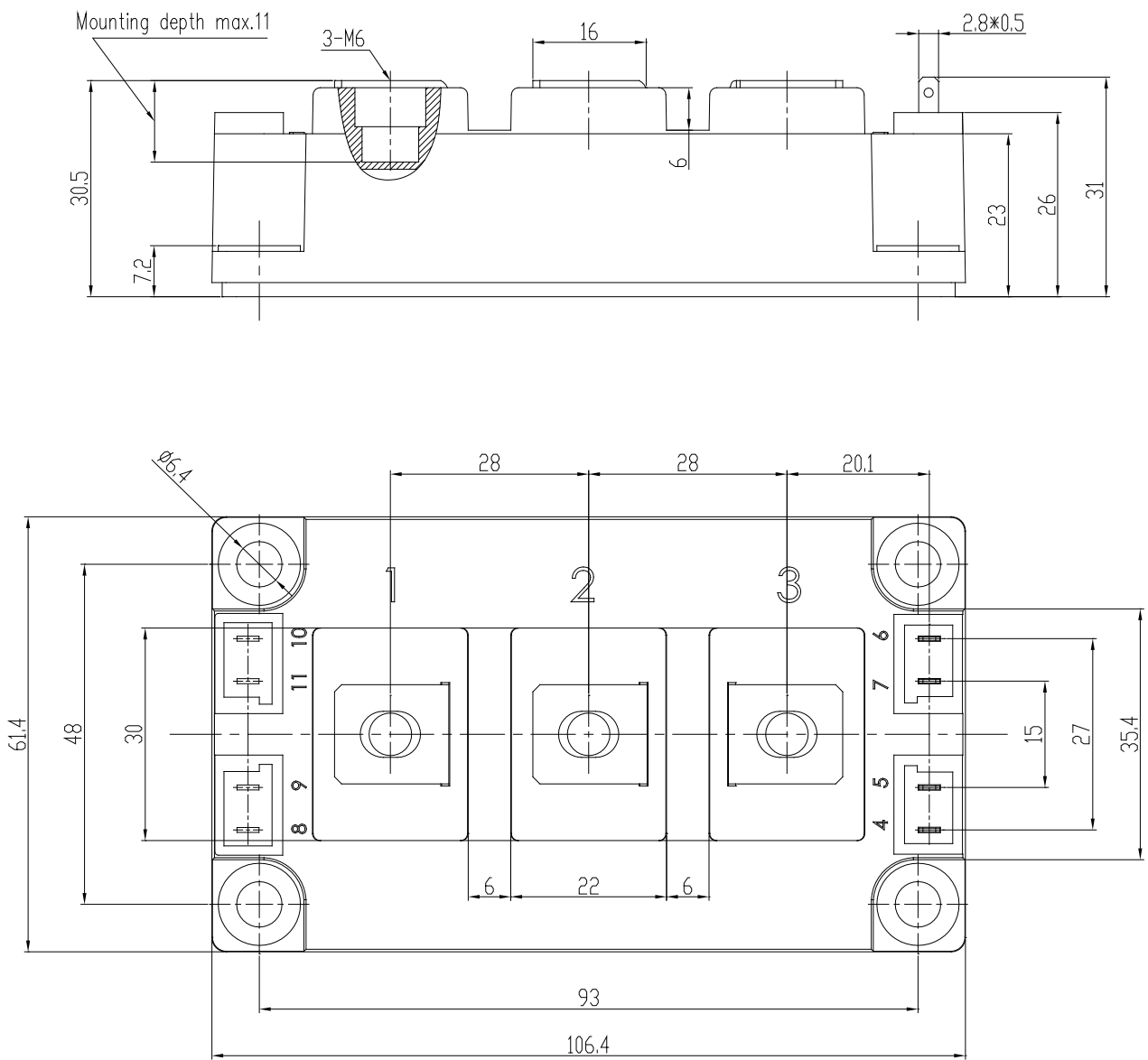

## Terms and Conditions of Usage

The data contained in this product datasheet is exclusively intended for technically trained staff. you and your technical departments will have to evaluate the suitability of the product for the intended application and the completeness of the product data with respect to such application.

This product data sheet is describing the characteristics of this product for which a warranty is granted. Any such warranty is granted exclusively pursuant the terms and conditions of the supply agreement. There will be no guarantee of any kind for the product and its characteristics.

Should you require product information in excess of the data given in this product data sheet or which concerns the specific application of our product, please contact the sales office, which is responsible for you (see [www.powersemi.cc](http://www.powersemi.cc)), For those that are specifically interested we may provide application notes.

Due to technical requirements our product may contain dangerous substances. For information on the types in question please contact the sales office, which is responsible for you.

Should you intend to use the Product in aviation applications, in health or live endangering or life support applications, please notify.

If and to the extent necessary, please forward equivalent notices to your customers.  
Changes of this product data sheet are reserved.