

atrin **electronic**

Expertise, variety and quality



www.atrinelec.com

آترین الکترونیک

تخصص، تنوع و کیفیت

02166766957 - 02166766927



info@atrinelec.com



تهران پاساژ امجد طبقه 1 واحد 16



@atrinelec



LM311

Single Comparator

Features

- Low input bias current : 250nA (Max)
- Low input offset current : 50nA (Max)
- Differential Input Voltage : $\pm 30V$
- Power supply voltage : single 5.0V supply to $\pm 15V$.
- Offset voltage null capability.
- Strobe capability.

Description

The LM311 series is a monolithic, low input current voltage comparator. The device is also designed to operate from dual or single supply voltage.

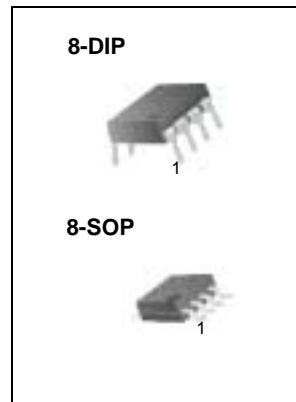

Internal Block Diagram

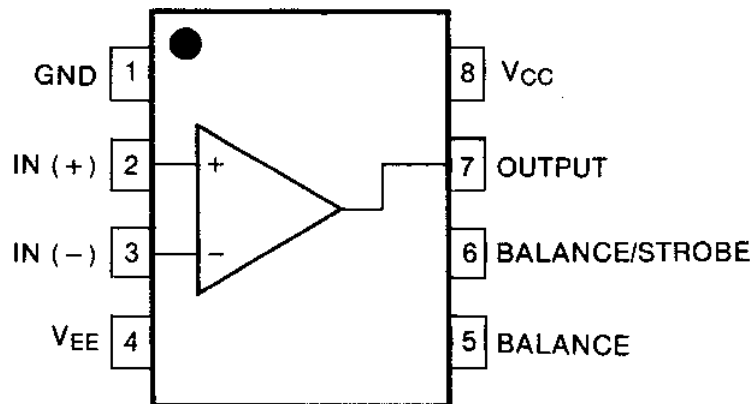

Schematic Diagram

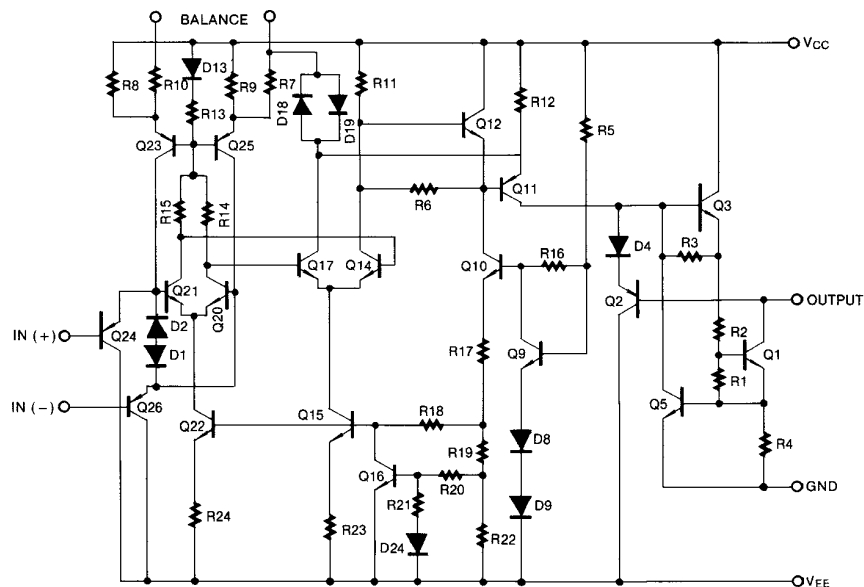

Absolute Maximum Ratings

Parameter	Symbol	Value	Unit
Total Supply Voltage	VCC	36	V
Output to Negative Supply Voltage LM311	VO - VEE	40	V
Ground to Negative voltage	VEE	-30	V
Differential Input Voltage	VI(DIFF)	30	V
Input Voltage	VI	±15	V
Output Short Circuit Duration	-	10	sec
Power Dissipation	PD	500	mW
Operating Temperature Range	TOPR	0 ~ +70	°C
Storage Temperature Range	TSTG	- 65 ~ +150	°C

Electrical Characteristics

($V_{CC} = 15V$, $T_A = 25^\circ C$, unless otherwise specified)

Parameter	Symbol	Conditions	Min.	Typ.	Max.	Unit
Input Offset Voltage	V_{IO}	$R_S \leq 50K\Omega$	-	1.0	7.5	mV
			Note 1	-	-	
Input Offset Current	I_{IO}		-	6	50	nA
			Note 1	-	-	
Input Bias Current	I_{BIAS}		-	100	250	nA
			Note 1	-	-	
Voltage Gain	G_V	-	40	200	-	V/mV
Response Time	T_{RES}	Note 2	-	200	-	ns
Saturation Voltage	V_{SAT}	$I_O = 50mA$, $V_I \leq -10mV$	-	0.75	1.5	V
		$V_{CC} \geq 4.5V$, $V_{EE} = 0V$ $I_O = 8mA$, $V_I \leq -10mV$, Note 1	-	0.23	0.4	
Strobe "ON" Current	$I_{STR(ON)}$	-	-	3	-	mA
Output Leakage Current	I_{SINK}	$I_{STR} = 3mA$, $V_I \geq 10mV$ $V_O = 15V$, $V_{CC} = \pm 15V$	-	0.2	50	nA
Input Voltage Range	$V_{I(R)}$	Note 1	-14.5 to 13.0	-14.7 to 13.8	-	V
Positive Supply Current	I_{CC}	-	-	3.0	7.5	mA
Negative Supply Current	I_{EE}	-	-	-2.2	-5.0	mA
Strobe Current	I_{STR}	-	-	3	-	mA

Notes :

- $0 \leq T_A \leq +70^\circ C$
- The response time specified is for a 100mV input step with 5mV over drive.

Typical Performance Characteristics

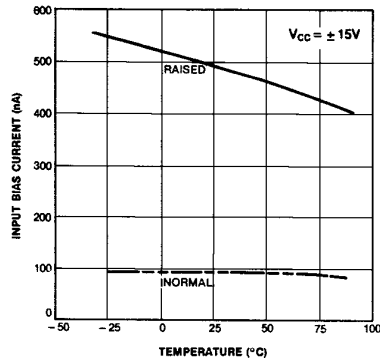

Figure 1. Input Bias Current vs Temperature

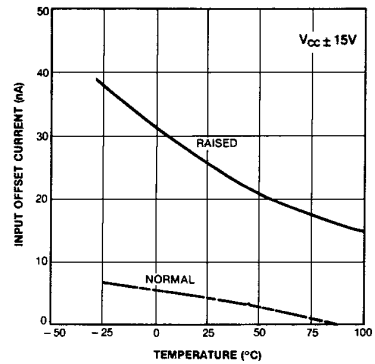

Figure 2. Input Offset Current vs Temperature

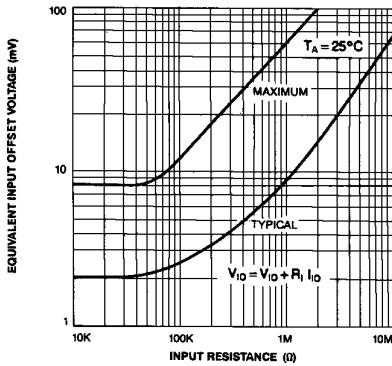

Figure 3. Offset Voltage vs Input Resistance

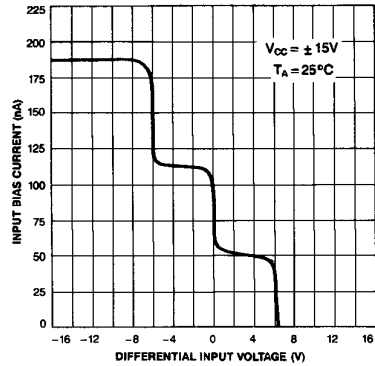

Figure 4. Input Bias Current vs Differential input voltage

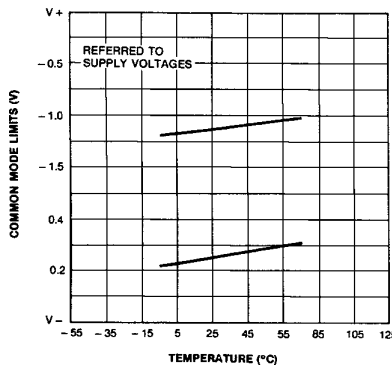

Figure 5. Common Mode Limits vs Temperature

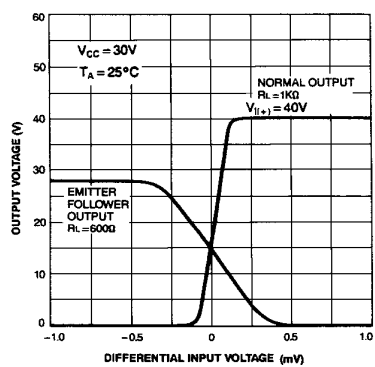

Figure 6. Output Voltage vs Differential input voltage

Typical Performance Characteristics (continued)

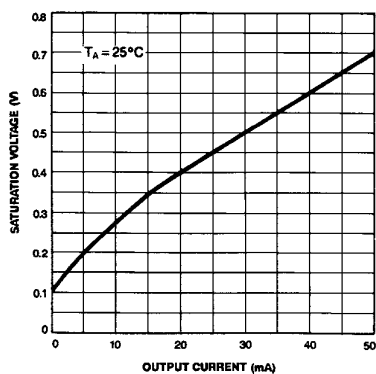

Figure 7. Saturation voltage vs Current

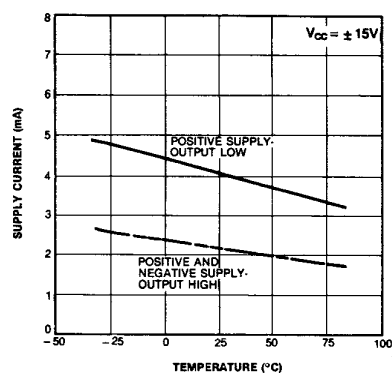

Figure 8. Supply Current vs Temperature

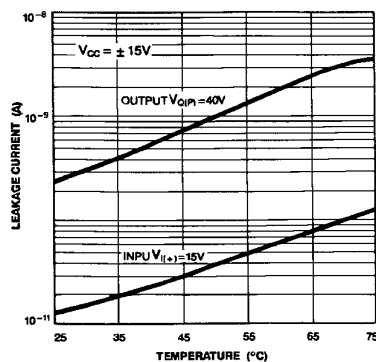

Figure 9. Leakage Current vs Temperature

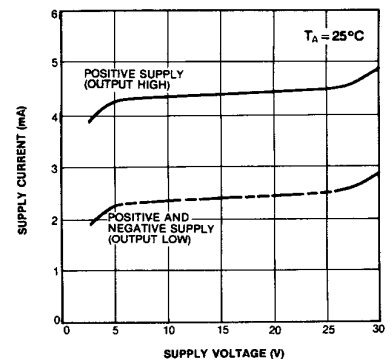

Figure 10. Supply Current vs Supply Voltage

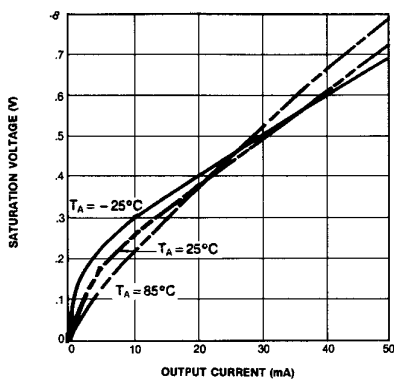

Figure 11. Current Saturation Voltage

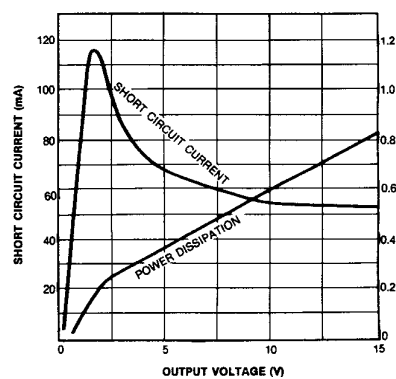
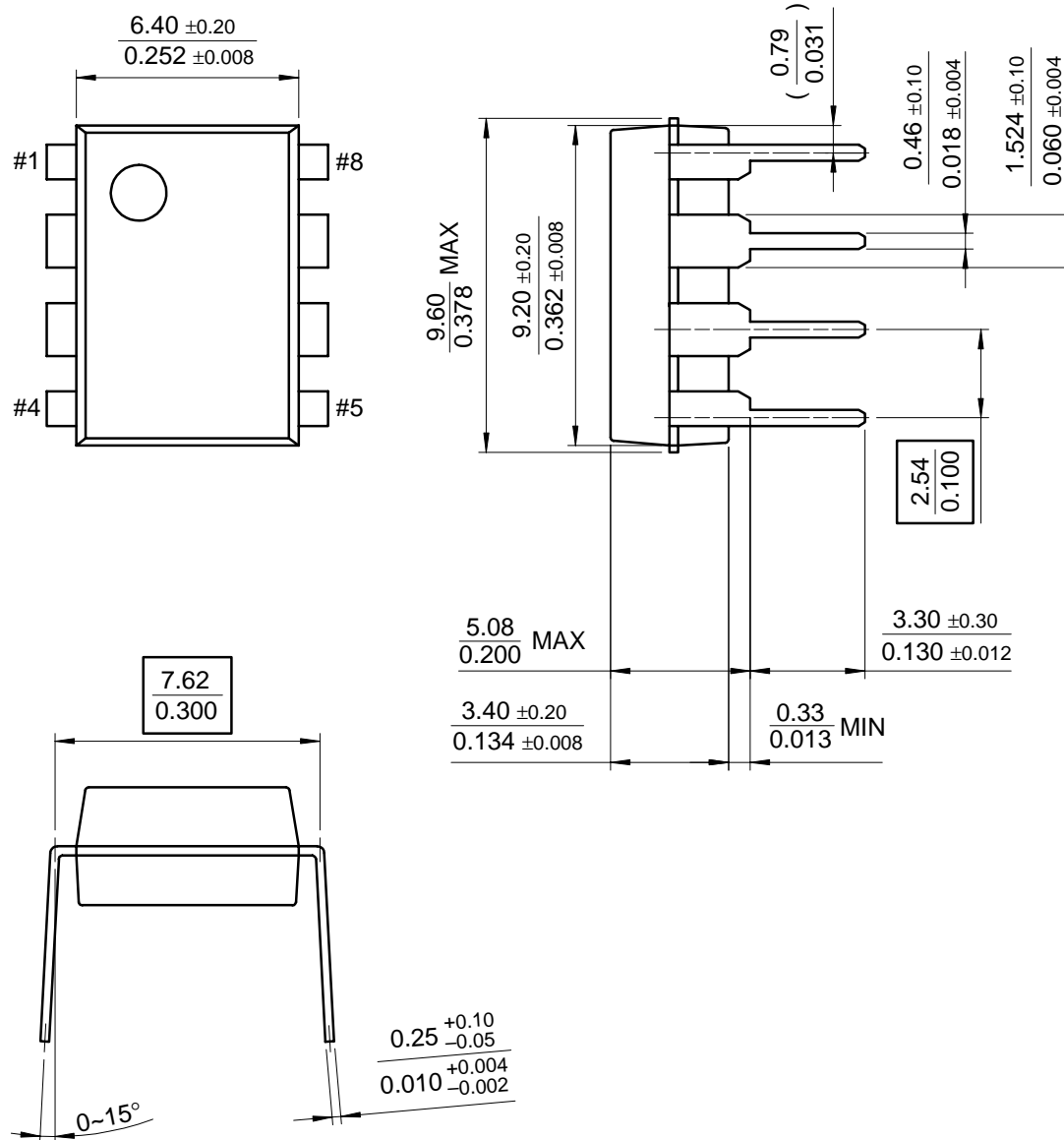

Figure 12. Output Limiting Characteristics

Mechanical Dimensions

Package

8-DIP



Mechanical Dimensions (Continued)

Package

8-SOP

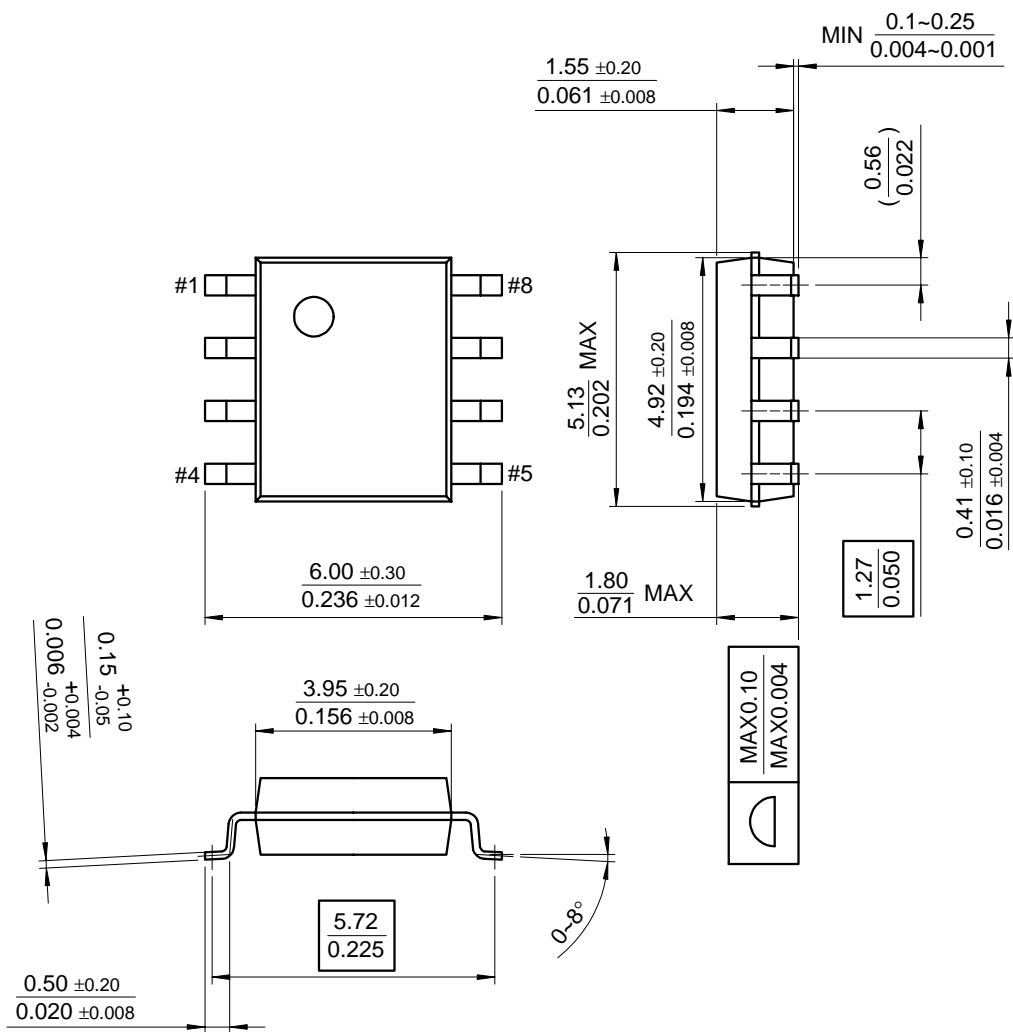

Ordering Information

Product Number	Package	Operating Temperature
LM311N	8-DIP	0 ~ +70°C
LM311M	8-SOP	

DISCLAIMER

FAIRCHILD SEMICONDUCTOR RESERVES THE RIGHT TO MAKE CHANGES WITHOUT FURTHER NOTICE TO ANY PRODUCTS HEREIN TO IMPROVE RELIABILITY, FUNCTION OR DESIGN. FAIRCHILD DOES NOT ASSUME ANY LIABILITY ARISING OUT OF THE APPLICATION OR USE OF ANY PRODUCT OR CIRCUIT DESCRIBED HEREIN; NEITHER DOES IT CONVEY ANY LICENSE UNDER ITS PATENT RIGHTS, NOR THE RIGHTS OF OTHERS.

LIFE SUPPORT POLICY

FAIRCHILD'S PRODUCTS ARE NOT AUTHORIZED FOR USE AS CRITICAL COMPONENTS IN LIFE SUPPORT DEVICES OR SYSTEMS WITHOUT THE EXPRESS WRITTEN APPROVAL OF THE PRESIDENT OF FAIRCHILD SEMICONDUCTOR CORPORATION. As used herein:

1. Life support devices or systems are devices or systems which, (a) are intended for surgical implant into the body, or (b) support or sustain life, and (c) whose failure to perform when properly used in accordance with instructions for use provided in the labeling, can be reasonably expected to result in a significant injury of the user.
2. A critical component in any component of a life support device or system whose failure to perform can be reasonably expected to cause the failure of the life support device or system, or to affect its safety or effectiveness.