

atrin **electronic**

Expertise, variety and quality



www.atrinelec.com

آترین الکترونیک

تخصص، تنوع و کیفیت

02166766957 - 02166766927



info@atrinelec.com



تهران پاساژ امجد طبقه 1 واحد 16



@atrinelec



Dual Power MOSFET Module

VMK 90-02T2

$V_{DSS} = 200\text{ V}$
 $I_{D25} = 83\text{ A}$
 $R_{DS(on)} = 25\text{ m}\Omega$

Common-Source connected
N-Channel Enhancement Mode

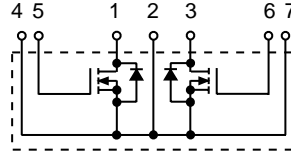

Symbol	Test Conditions	Maximum Ratings	
V_{DSS}	$T_J = 25^\circ\text{C}$ to 150°C	200	V
V_{DGR}	$T_J = 25^\circ\text{C}$ to 150°C ; $R_{GS} = 6.8\text{ k}\Omega$	200	V
V_{GS}	Continuous	± 20	V
V_{GSM}	Transient	± 30	V
I_{D25}	$T_C = 25^\circ\text{C}$	83	A
I_{D80}	$T_C = 80^\circ\text{C}$	62	A
I_{DM}	$T_C = 25^\circ\text{C}$, $t_p = 10\text{ }\mu\text{s}$, pulse width limited by T_{JM}	330	A
P_D	$T_C = 25^\circ\text{C}$, $T_J = 150^\circ\text{C}$,	380	W
T_J		-40 ... +150	$^\circ\text{C}$
T_{JM}		150	$^\circ\text{C}$
T_{stg}		-40 ... +125	$^\circ\text{C}$
V_{ISOL}	50/60 Hz	$t = 1\text{ min}$	2500 V~
	$I_{ISOL} \leq 1\text{ mA}$	$t = 1\text{ s}$	3000 V~
M_d	Mounting torque(M5 or 10-32 UNF)	2.5-4.0/22-35 Nm/lb.in.	
	Terminal connection torque (M5)	2.5-4.0/22-35 Nm/lb.in.	
Weight	Typical including screws	90	g

TO-240 AA
E 72873

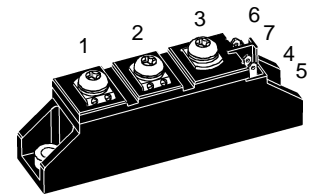

1, 3 = Drain, 2 = Common Source
5, 6 = Gate, 4, 7 = Kelvin Source

Features

- Two MOSFET with common source
- International standard package JEDEC TO-240 AA
- Direct copper bonded Al_2O_3 ceramic base plate
- Isolation voltage 3000 V~
- Low $R_{DS(on)}$ HDMOS™ process
- Low package inductance for high speed switching
- Kelvin source contact
- Keyed twin plugs

Applications

- Push-pull inverters
- Switched-mode and resonant-mode power supplies
- Uninterruptible power supplies (UPS)
- AC static switches

Advantages

- Easy to mount with two screws
- Space and weight savings
- High power density
- Low losses

Symbol	Test Conditions	Characteristic Values ($T_J = 25^\circ\text{C}$, unless otherwise specified)		
		min.	typ.	max.
V_{DSS}	$V_{GS} = 0\text{ V}$, $I_D = 1\text{ mA}$	200		V
$V_{GS(th)}$	$V_{DS} = V_{GS}$, $I_D = 3\text{ mA}$	2		4 V
I_{GSS}	$V_{GS} = \pm 20\text{ V DC}$, $V_{DS} = 0$			500 nA
I_{DSS}	$V_{DS} = 0.8 \cdot V_{DSS}$, $V_{GS} = 0\text{ V}$, $T_J = 25^\circ\text{C}$ $V_{GS} = 0\text{ V}$, $T_J = 125^\circ\text{C}$			400 μA 2 mA
$R_{DS(on)}$	$V_{GS} = 10\text{ V}$, $I_D = 0.5 \cdot I_{D25}$ Pulse test, $t \leq 300\text{ }\mu\text{s}$, duty cycle $d \leq 2\%$			25 $\text{m}\Omega$

Symbol	Test Conditions	Characteristic Values ($T_J = 25^\circ\text{C}$, unless otherwise specified)		
		min.	typ.	max.
g_{fs}	$V_{DS} = 10\text{ V}; I_D = 0.5 \cdot I_{D25}$ pulsed		60	S
C_{iss}	} $V_{GS} = 0\text{ V}, V_{DS} = 25\text{ V}, f = 1\text{ MHz}$		9000	15000 pF
C_{oss}			1600	4500 pF
C_{rss}			600	1500 pF
$t_{d(on)}$	} $V_{GS} = 10\text{ V}, V_{DS} = 0.5 \cdot V_{DSS}, I_D = 0.5 \cdot I_{D25}$ $R_G = 1\ \Omega$ (External), resistive load			70 ns
t_r				80 ns
$t_{d(off)}$				200 ns
t_f				100 ns
Q_g	} $V_{GS} = 10\text{ V}, V_{DS} = 0.5 \cdot V_{DSS}, I_D = 0.5 \cdot I_{D25}$		380	450 nC
Q_{gs}			70	110 nC
Q_{gd}			190	230 nC
R_{thJC}				0.33 K/W
R_{thJK}	with heat transfer paste			0.53 K/W
d_s	Creepage distance on surface	12.7		mm
d_A	Strike distance through air	9.6		mm
a	Max. allowable acceleration		50	m/s^2

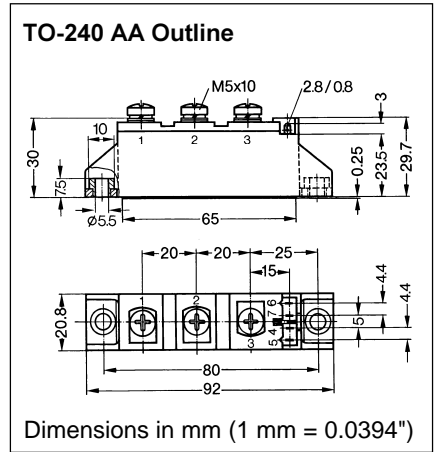

Symbol	Test Conditions	Characteristic Values ($T_J = 25^\circ\text{C}$, unless otherwise specified)		
		min.	typ.	max.
I_S	$V_{GS} = 0\text{ V}$			83 A
I_{SM}	Repetitive; pulse width limited by T_{JM}			330 A
V_{SD}	$I_F = I_S; V_{GS} = 0\text{ V}$, Pulse test, $t \leq 300\ \mu\text{s}$, duty cycle $d \leq 2\%$		1.0	1.2 V
t_{rr}	$I_F = I_S, -di/dt = 100\text{ A}/\mu\text{s}, V_{DS} = 100\text{ V}, V_{GS} = 0\text{ V}$		400	750 ns

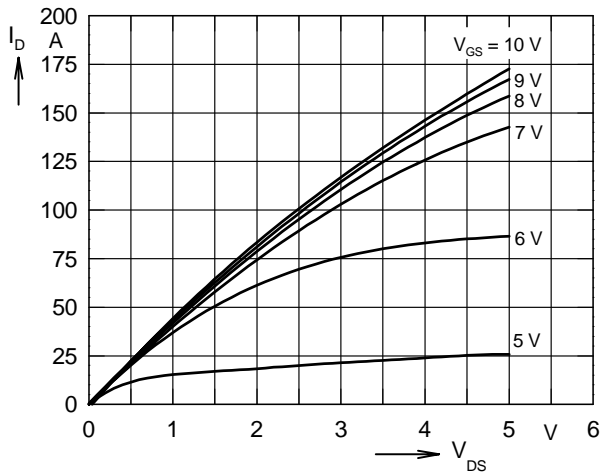

Fig. 1 Typical output characteristics $I_D = f(V_{DS})$

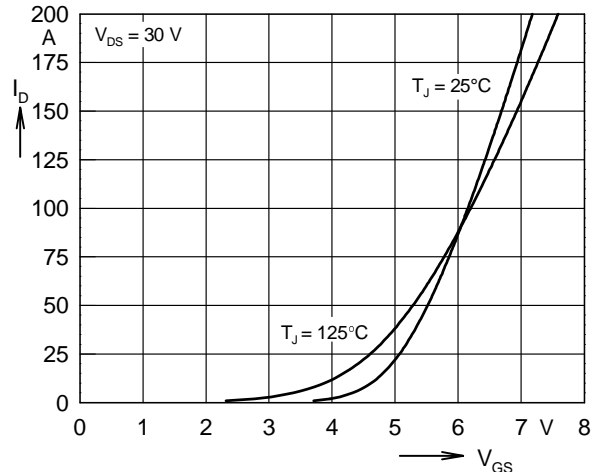

Fig. 2 Typical transfer characteristics $I_D = f(V_{GS})$

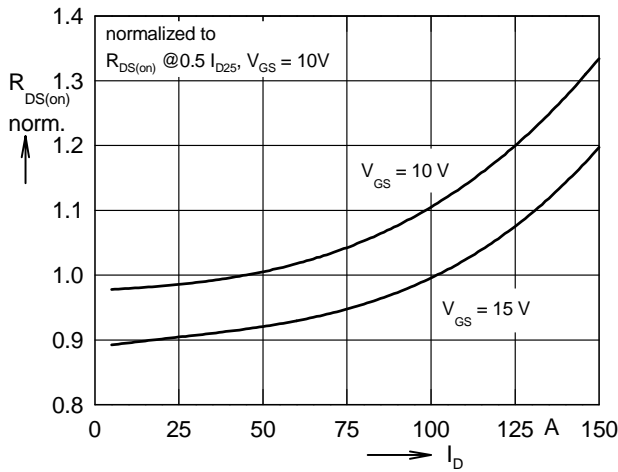

Fig. 3 Typical normalized $R_{DS(on)} = f(I_D)$

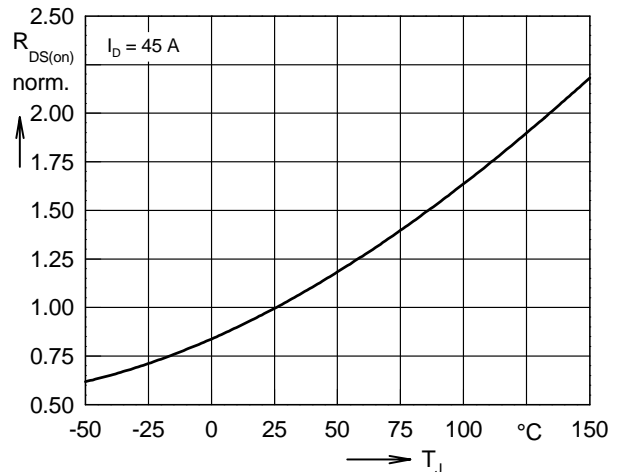

Fig. 4 Typical normalized $R_{DS(on)} = f(T_J)$

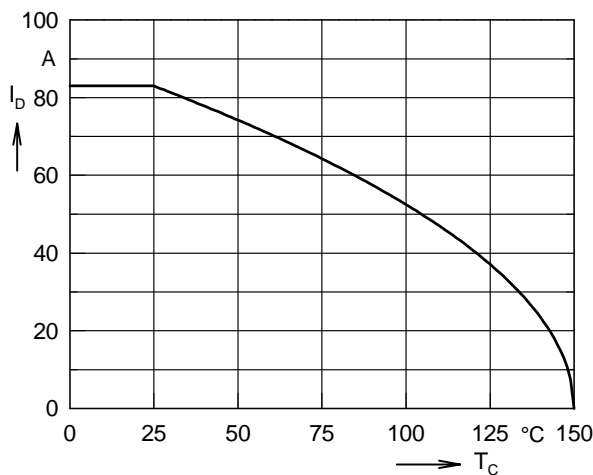

Fig. 5 Continuous drain current $I_D = f(T_C)$

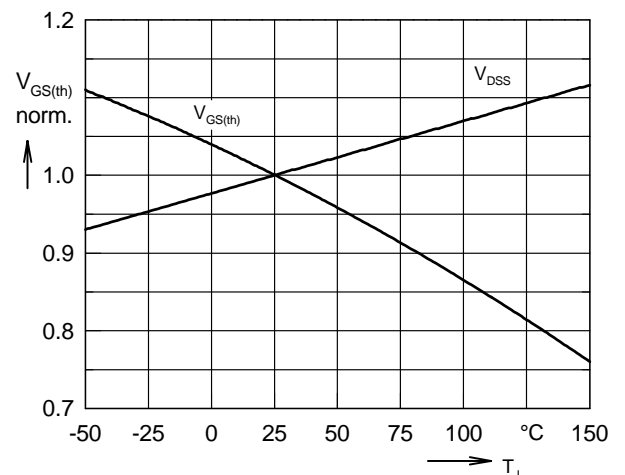

Fig. 6 Typical normalized $V_{DSS} = f(T_J)$, $V_{GS(th)} = f(T_J)$

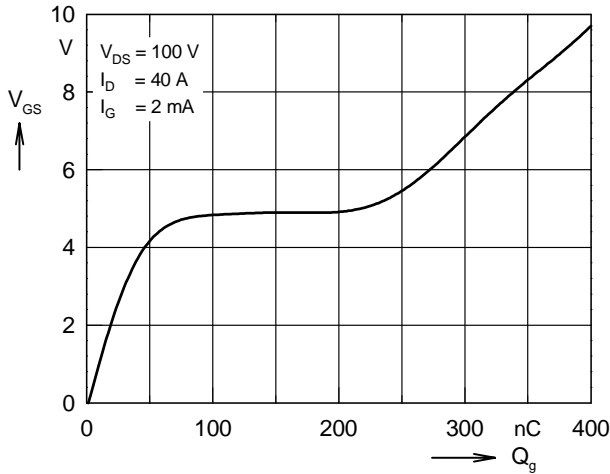

Fig. 7 Typical turn-on gate charge characteristics

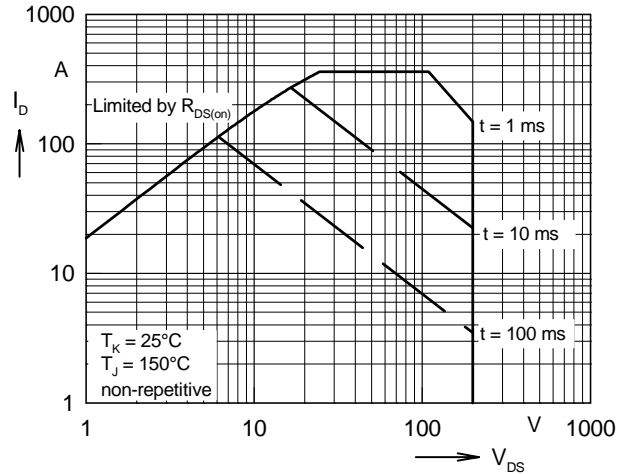

Fig. 8 Forward Safe Operating Area, $I_D = f(V_{DS})$

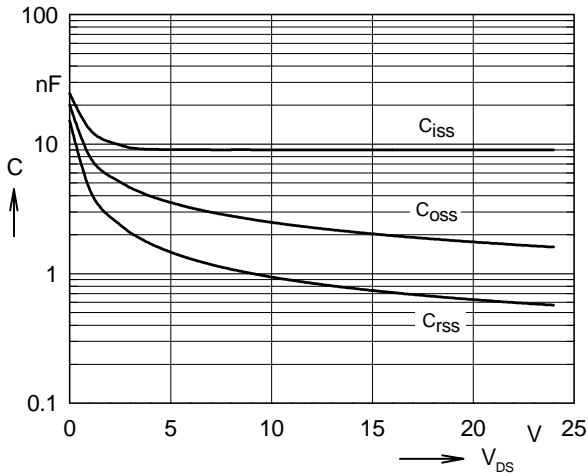

Fig. 9 Typical capacitances $C = f(V_{DS})$, $f = 1 \text{ MHz}$

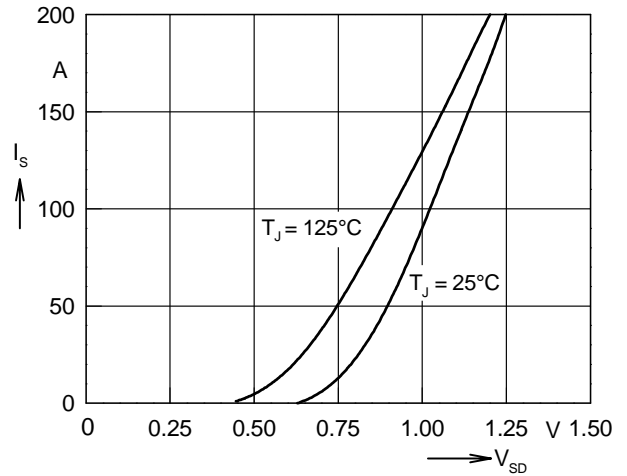

Fig. 10 Typical forward characteristics of reverse diode, $I_S = f(V_{SD})$

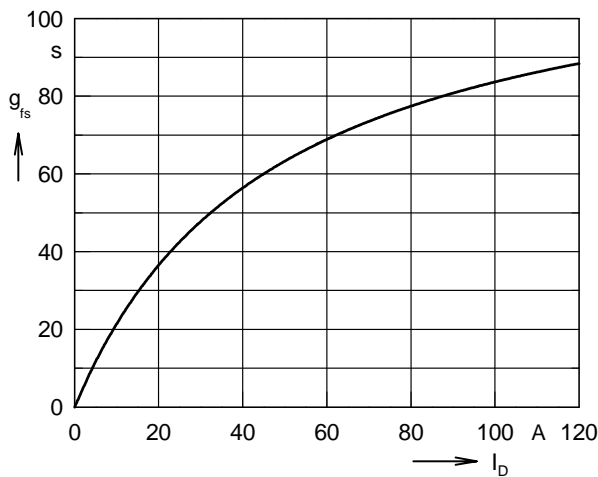

Fig. 11 Typical transconductance $g_{fs} = f(I_D)$

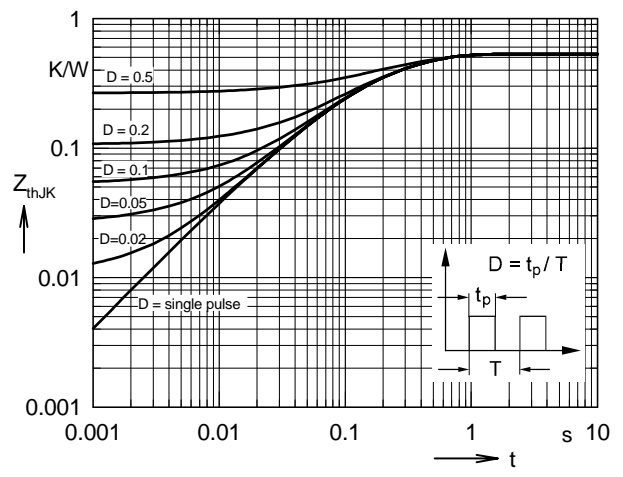

Fig. 12 Transient thermal resistance $Z_{thJK} = f(t_p)$