

atrin **electronic**

Expertise, variety and quality



www.atrinelec.com

آترین الکترونیک

تخصص، تنوع و کیفیت

02166766957 - 02166766927



info@atrinelec.com



تهران پاساژ امجد طبقه 1 واحد 16



@atrinelec





6-Pin DIP Random-Phase Optoisolators Triac Driver Output (400 Volts Peak)

The MOC3020 Series consists of gallium arsenide infrared emitting diodes, optically coupled to a silicon bilateral switch.

- To order devices that are tested and marked per VDE 0884 requirements, the suffix "V" must be included at end of part number. VDE 0884 is a test option.**

They are designed for applications requiring isolated triac triggering.

Recommended for 115/240 Vac(rms) Applications:

- Solenoid/Valve Controls
- Lamp Ballasts
- Interfacing Microprocessors to 115 Vac Peripherals
- Motor Controls
- Static ac Power Switch
- Solid State Relays
- Incandescent Lamp Dimmers

MAXIMUM RATINGS ($T_A = 25^\circ\text{C}$ unless otherwise noted)

| Rating | Symbol | Value | Unit |
|--------|--------|-------|------|
|--------|--------|-------|------|

INFRARED EMITTING DIODE

| | | | |
|---|-------|-------------|-------------|
| Reverse Voltage | V_R | 3 | Volts |
| Forward Current — Continuous | I_F | 60 | mA |
| Total Power Dissipation @ $T_A = 25^\circ\text{C}$ Negligible Power in Triac Driver Derate above 25°C | P_D | 100 1.33 | mW mW/°C |

OUTPUT DRIVER

| | | | |
|---|-----------|----------|-------------|
| Off-State Output Terminal Voltage | V_{DRM} | 400 | Volts |
| Peak Repetitive Surge Current ($PW = 1 \text{ ms}, 120 \text{ pps}$) | I_{TSM} | 1 | A |
| Total Power Dissipation @ $T_A = 25^\circ\text{C}$ Derate above 25°C | P_D | 300 4 | mW mW/°C |

TOTAL DEVICE

| | | | |
|---|-----------|-------------|-------------|
| Isolation Surge Voltage ⁽¹⁾ (Peak ac Voltage, 60 Hz, 1 Second Duration) | V_{ISO} | 7500 | Vac(pk) |
| Total Power Dissipation @ $T_A = 25^\circ\text{C}$ Derate above 25°C | P_D | 330 4.4 | mW mW/°C |
| Junction Temperature Range | T_J | -40 to +100 | °C |
| Ambient Operating Temperature Range ⁽²⁾ | T_A | -40 to +85 | °C |
| Storage Temperature Range ⁽²⁾ | T_{stg} | -40 to +150 | °C |
| Soldering Temperature (10 s) | T_L | 260 | °C |

- Isolation surge voltage, V_{ISO} , is an internal device dielectric breakdown rating. For this test, Pins 1 and 2 are common, and Pins 4, 5 and 6 are common.
- Refer to Quality and Reliability Section in Opto Data Book for information on test conditions.

Preferred devices are Motorola recommended choices for future use and best overall value. GlobalOptoisolator is a trademark of Motorola, Inc.

MOC3021
[IFT = 15 mA Max]
MOC3022
[IFT = 10 mA Max]
MOC3023*
[IFT = 5 mA Max]

*Motorola Preferred Device

STYLE 6 PLASTIC

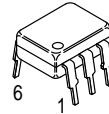

STANDARD THRU HOLE
CASE 730A-04

SCHEMATIC

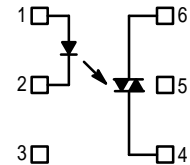

- ANODE
- CATHODE
- NC
- MAIN TERMINAL
- SUBSTRATE
DO NOT CONNECT
- MAIN TERMINAL

MOC3021 MOC3022 MOC3023

ELECTRICAL CHARACTERISTICS ($T_A = 25^\circ\text{C}$ unless otherwise noted)

| Characteristic | Symbol | Min | Typ | Max | Unit |
|---|--------|-----|------|-----|---------------|
| INPUT LED | | | | | |
| Reverse Leakage Current ($V_R = 3\text{ V}$) | I_R | — | 0.05 | 100 | μA |
| Forward Voltage ($I_F = 10\text{ mA}$) | V_F | — | 1.15 | 1.5 | Volts |

OUTPUT DETECTOR ($I_F = 0$ unless otherwise noted)

| | | | | | |
|--|-----------|---|-----|-----|------------------------|
| Peak Blocking Current, Either Direction (Rated $V_{DRM}^{(1)}$) | I_{DRM} | — | 10 | 100 | nA |
| Peak On-State Voltage, Either Direction ($I_{TM} = 100\text{ mA Peak}$) | V_{TM} | — | 1.8 | 3 | Volts |
| Critical Rate of Rise of Off-State Voltage (Figure 7, Note 2) | dv/dt | — | 10 | — | $\text{V}/\mu\text{s}$ |

COUPLED

| | | | | | |
|--|----------|---|-----|----|---------------|
| LED Trigger Current, Current Required to Latch Output (Main Terminal Voltage = 3 V ⁽³⁾) | I_{FT} | — | 8 | 15 | mA |
| MOC3021 | | — | — | 10 | |
| MOC3022 | | — | — | 5 | |
| MOC3023 | — | — | — | — | — |
| Holding Current, Either Direction | I_H | — | 100 | — | μA |

1. Test voltage must be applied within dv/dt rating.
2. This is static dv/dt . See Figure 7 for test circuit. Commutating dv/dt is a function of the load-driving thyristor(s) only.
3. All devices are guaranteed to trigger at an I_F value less than or equal to max I_{FT} . Therefore, recommended operating I_F lies between max I_{FT} (15 mA for MOC3021, 10 mA for MOC3022, 5 mA for MOC3023) and absolute max I_F (60 mA).

TYPICAL ELECTRICAL CHARACTERISTICS

$T_A = 25^\circ\text{C}$

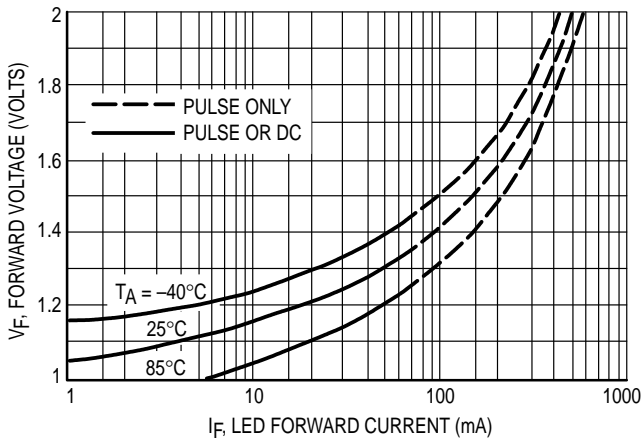

Figure 1. LED Forward Voltage versus Forward Current

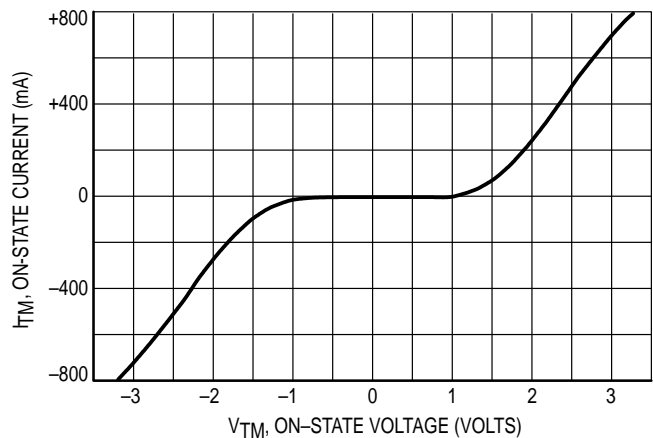

Figure 2. On-State Characteristics

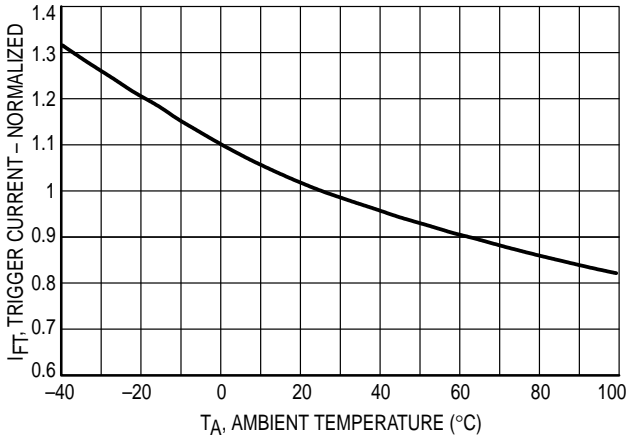

Figure 3. Trigger Current versus Temperature

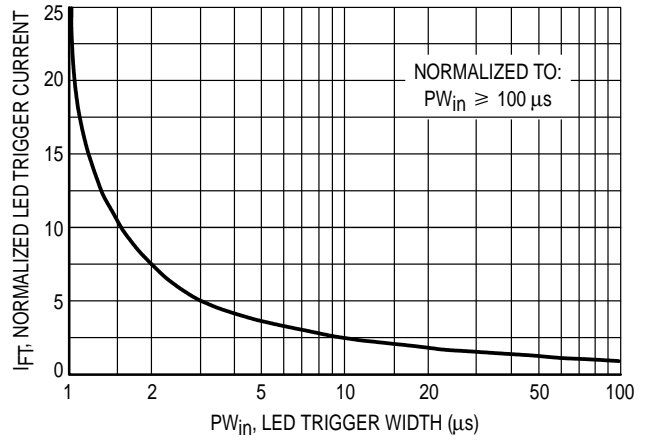

Figure 4. LED Current Required to Trigger versus LED Pulse Width

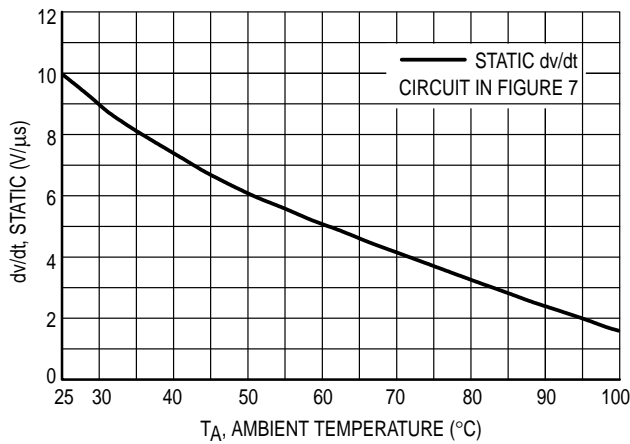

Figure 5. dv/dt versus Temperature

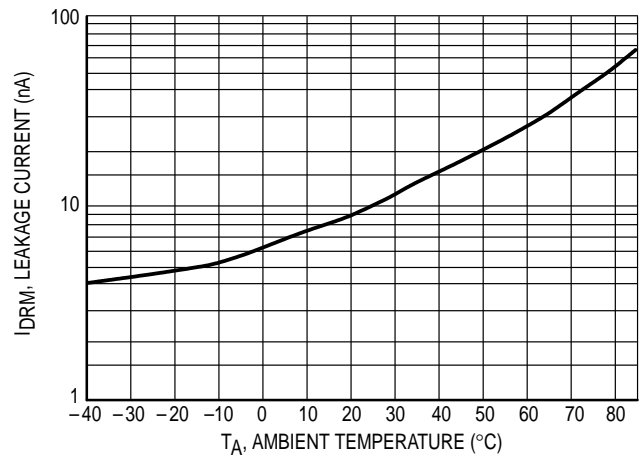

Figure 6. Leakage Current, IDRM versus Temperature

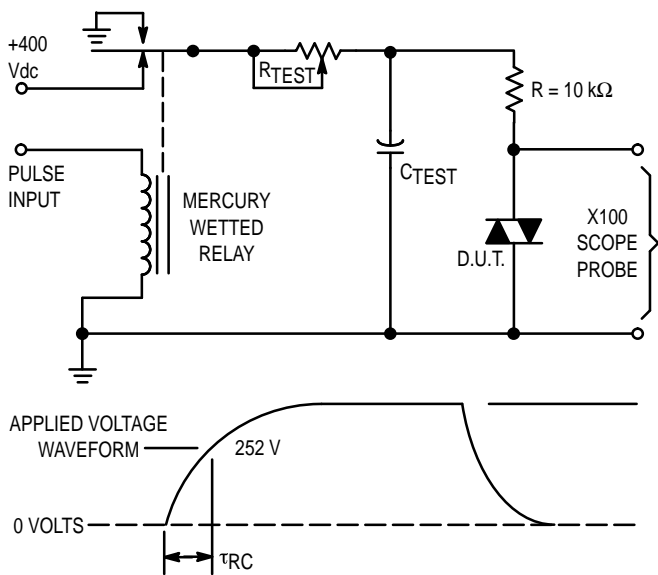
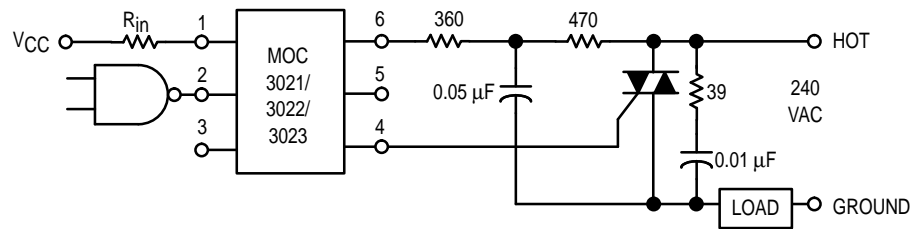

Figure 7. Static dv/dt Test Circuit

1. The mercury wetted relay provides a high speed repeated pulse to the D.U.T.
2. 100x scope probes are used, to allow high speeds and voltages.
3. The worst-case condition for static dv/dt is established by triggering the D.U.T. with a normal LED input current, then removing the current. The variable R_{TEST} allows the dv/dt to be gradually increased until the D.U.T. continues to trigger in response to the applied voltage pulse, even after the LED current has been removed. The dv/dt is then decreased until the D.U.T. stops triggering. τ_{RC} is measured at this point and recorded.

MOC3021 MOC3022 MOC3023



* This optoisolator should not be used to drive a load directly. It is intended to be a trigger device only.

Additional information on the use of optically coupled triac drivers is available in Application Note AN-780A.

In this circuit the "hot" side of the line is switched and the load connected to the cold or ground side.

The 39 ohm resistor and 0.01 μF capacitor are for snubbing of the triac, and the 470 ohm resistor and 0.05 μF capacitor are for snubbing the coupler. These components may or may not be necessary depending upon the particular triac and load used.

Figure 8. Typical Application Circuit

PACKAGE DIMENSIONS

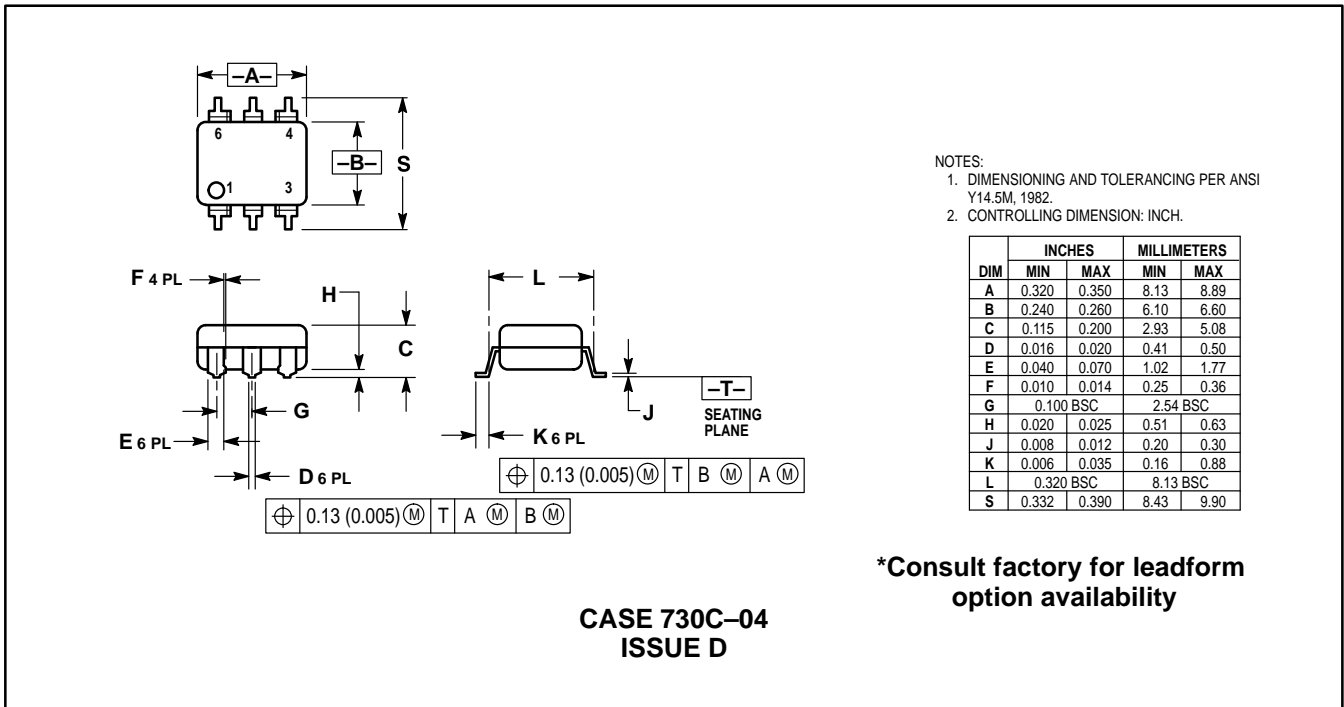
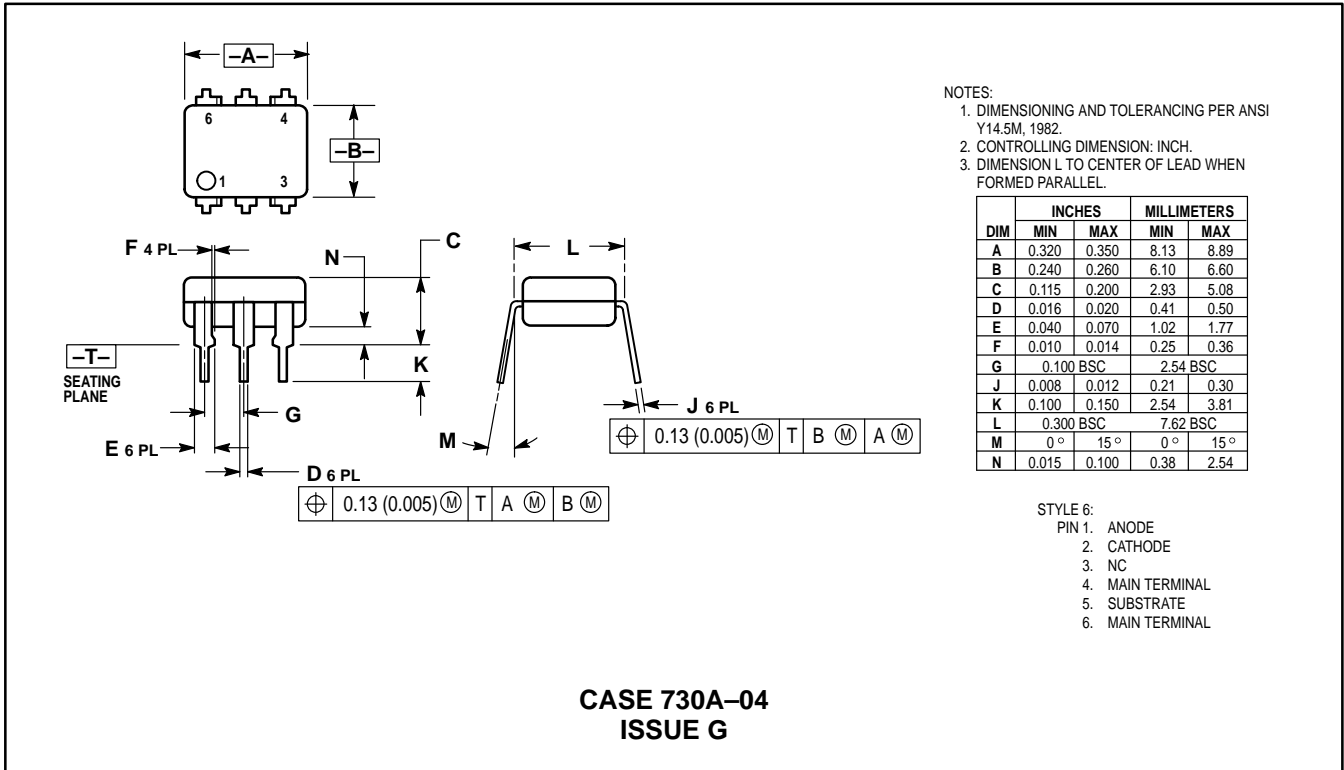

MOC3021 MOC3022 MOC3023

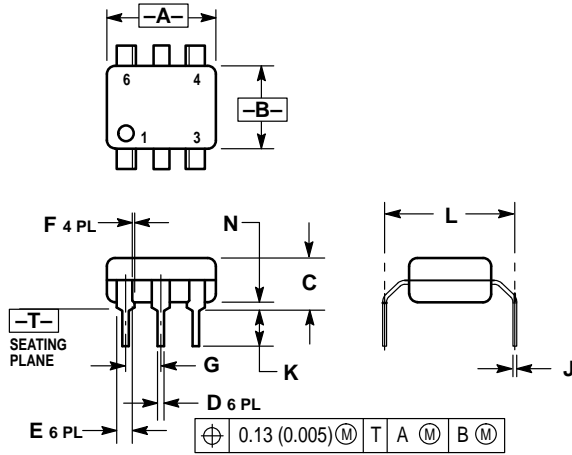

- NOTES:
1. DIMENSIONING AND TOLERANCING PER ANSI Y14.5M, 1982.
 2. CONTROLLING DIMENSION: INCH.
 3. DIMENSION L TO CENTER OF LEAD WHEN FORMED PARALLEL.

| DIM | INCHES | | MILLIMETERS | |
|-----|-----------|-------|-------------|-------|
| | MIN | MAX | MIN | MAX |
| A | 0.320 | 0.350 | 8.13 | 8.89 |
| B | 0.240 | 0.260 | 6.10 | 6.60 |
| C | 0.115 | 0.200 | 2.93 | 5.08 |
| D | 0.016 | 0.020 | 0.41 | 0.50 |
| E | 0.040 | 0.070 | 1.02 | 1.77 |
| F | 0.010 | 0.014 | 0.25 | 0.36 |
| G | 0.100 BSC | | 2.54 BSC | |
| J | 0.008 | 0.012 | 0.21 | 0.30 |
| K | 0.100 | 0.150 | 2.54 | 3.81 |
| L | 0.400 | 0.425 | 10.16 | 10.80 |
| N | 0.015 | 0.040 | 0.38 | 1.02 |

***Consult factory for leadform option availability**

**CASE 730D-05
ISSUE D**

Motorola reserves the right to make changes without further notice to any products herein. Motorola makes no warranty, representation or guarantee regarding the suitability of its products for any particular purpose, nor does Motorola assume any liability arising out of the application or use of any product or circuit, and specifically disclaims any and all liability, including without limitation consequential or incidental damages. "Typical" parameters can and do vary in different applications. All operating parameters, including "Typicals" must be validated for each customer application by customer's technical experts. Motorola does not convey any license under its patent rights nor the rights of others. Motorola products are not designed, intended, or authorized for use as components in systems intended for surgical implant into the body, or other applications intended to support or sustain life, or for any other application in which the failure of the Motorola product could create a situation where personal injury or death may occur. Should Buyer purchase or use Motorola products for any such unintended or unauthorized application, Buyer shall indemnify and hold Motorola and its officers, employees, subsidiaries, affiliates, and distributors harmless against all claims, costs, damages, and expenses, and reasonable attorney fees arising out of, directly or indirectly, any claim of personal injury or death associated with such unintended or unauthorized use, even if such claim alleges that Motorola was negligent regarding the design or manufacture of the part. Motorola and are registered trademarks of Motorola, Inc. Motorola, Inc. is an Equal Opportunity/Affirmative Action Employer.

How to reach us:

USA / EUROPE: Motorola Literature Distribution;
P.O. Box 20912; Phoenix, Arizona 85036. 1-800-441-2447

JAPAN: Nippon Motorola Ltd.; Tatsumi-SPD-JLDC, Toshikatsu Otsuki,
6F Seibu-Butsuryu-Center, 3-14-2 Tatsumi Koto-Ku, Tokyo 135, Japan. 03-3521-8315

MFAX: RMFAX0@email.sps.mot.com – TOUCHTONE (602) 244-6609
INTERNET: http://Design-NET.com

HONG KONG: Motorola Semiconductors H.K. Ltd.; 8B Tai Ping Industrial Park,
51 Ting Kok Road, Tai Po, N.T., Hong Kong. 852-26629298

