



深圳市海凌科电子有限公司 **Shenzhen Hi-Link Electronic Co.,Ltd**
[Http://www.hktech.com](http://www.hktech.com) Tel:0755-83575155 Fax:0755-83575189



Shenzhen Hi-Link Electronic Technology co., Ltd

HLK-RM04 User Manual

ETHERNET

WIFI

Full Function Serial Network/Wireless Module

1	BRIEF INTRODUCTION.....	5
2	SUMMARIZE.....	5

2.1	TECHNICAL SPECIFICATIONS	5
2.2	HARDWARE EXPLANATION	6
2.2.1	<i>Mechanical Dimensions</i>	6
3	QUICK START	8
3.1	RESTORE FACTORY SETTINGS	8
3.2	CONFIGURATE NETWORK PARAMETER	8
3.3	CONFIGURATE SERIAL NETWORK PARAMETER	9
4	FUNCTION DESCRIPTION	9
4.1	SERIAL TO ETHERNET.....	9
4.2	SERIAL TO WIFI CLIENT.....	10
4.3	SERIAL TO WIFI AP	10
4.4	DEFAULT MODE.....	11
4.5	PARAMETER CONFIGURATION DIRECTION	11
5	WEB CONFIGURATION	12
5.1	WEB NETWORK CONFIGURATION.....	12
5.1.1	<i>Serial to Ethernet-dynamic ip</i>	13
5.1.2	<i>Serial to Ethernet-static ip</i>	13
5.1.3	<i>Serial to WIFI CLIENT-dynamic ip</i>	13
5.1.4	<i>Serial to WIFI CLIENT-static ip</i>	14
5.1.5	<i>Serial to WIFI AP</i>	14
5.2	WEB SERIAL CONFIGURATION	14
6	SERIAL AT COMMAND CONFIGURATION	16
6.1	ACCESS TO AT COMMAND MODE.....	16
6.2	AT COMMAND	16
6.2.1	<i>Net mode</i>	17
6.2.2	<i>wifi_conf</i>	18
6.2.3	<i>dhcpc</i>	18
6.2.4	<i>net_ip</i>	19
6.2.5	<i>net_dns</i>	19
6.2.6	<i>dhcpd</i>	19
6.2.7	<i>dhcpd_ip</i>	20
6.2.8	<i>dhcpd_dns</i>	20

6.2.9	<i>dhcpcd_time</i>	20
6.2.10	<i>net_commit</i>	20
6.2.11	<i>out_trans</i>	21
6.2.12	<i>remoteip</i>	21
6.2.13	<i>remoteport</i>	21
6.2.14	<i>remotepro</i>	22
6.2.15	<i>timeout</i>	22
6.2.16	<i>mode</i>	22
6.2.17	<i>uart</i>	23
6.2.18	<i>uartpacklen</i>	23
6.2.19	<i>uartpacktimeout</i>	23
6.2.20	<i>save</i>	23
6.2.21	<i>reconn</i>	24
6.2.22	<i>ver</i>	24
6.3	AT COMMAND CONTROL CODE ROUTION	24
6.3.1	<i>Inquiry configuration information</i>	24
6.3.2	<i>Serial to Ethernet(Dynamic ip address)</i>	25
6.3.3	<i>Serial to Ethernet(static ip address)</i>	26
6.3.4	<i>Serial to wifi client(dynamic IP address)</i>	27
6.3.5	<i>Serial to wifi client(static IP address)</i>	28
6.3.6	<i>Serial to wifi AP</i>	29
6.3.7	<i>Restore factory value</i>	30
7	SERIAL CONFIGURATION TOOLS	30
7.1	SEARCHING THE MODULE.....	32
7.2	SET EACH PARAMETERS.....	32
7.3	SUBMIT THE CONFIGURATION.....	33
7.4	USER DATA RETENTION	34
7.5	INQUIRY CONFIGURATION	34
7.6	ACCESS TO TRANSPARENT TRANSMISSION MODE.....	34
7.7	RESTORE FACTORY FACTORY VALUE SETTING.....	34
8	DEVICE SEARCH TOOLS	35
9	RESTORE FACTORY SETTINGS	36
10	FIRMWARE UPGRADE	37



深圳市海凌科电子有限公司 **Shenzhen Hi-Link Electronic Co.,Ltd**
[Http://www.hlktech.com](http://www.hlktech.com) Tel:0755-83575155 Fax:0755-83575189

APPENDIX A DOCUMENT REVISION RECORD.....37

1 Brief Introduction

HLK-RM04 is a new low-cost embedded UART-ETH-WIFI module (serial port - Ethernet - Wireless network) developed by Shenzhen Hi-Link ElectronicTechnology co., Ltd

This product is an embedded module based on the universal serial interface network standard, built-in TCP / IP protocol stack, enabling the user serial port, Ethernet, wireless network (wifi) interface between the conversions.

Through the HLK-RM04 module, the traditional serial devices do not need to change any configuration; data can be transmitted through the Internet network. Provide a quick solution for the user's serial devices to transfer data via Ethernet.

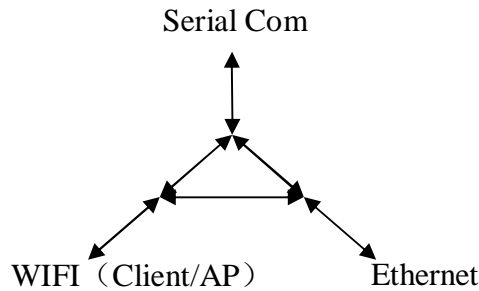

Picture1.F-structure

2 Summarize

2.1 Technical Specifications

Table2-1 Technical Specifications

Network standard	wireless: IEEE 802.11n、IEEE 802.11g、IEEE 802.11b
	wired: IEEE 802.3、IEEE 802.3u
Wireless transmission rate	11n: maximum up to 150Mbps
	11g: maximum up to 54Mbps
	11b: maximum up to 11Mbps
Tracks number	1-14
Frequency range	2.4-2.4835G
Emission power	12-15DBM
Interface	1 个 10/100Mbps LAN/WAN multiplex interface、 interface
Antenna	
Antenna type	Onboard antenna / External Antenna

Functional Parameters	
WIFI work mode	Client/AP/Router
WDS Function	Support WDS wireless bridge connection
Wireless security	Wireless MAC address filtering
	Wireless security function switch
	64/128/152 bit WEP encryption
	WPA-PSK/WPA2-PSK、WPA/WPA2 security mechanism
Network management	Remote Web management
	Configuration file import and export
	WEB software upgrade
Serial to Ethernet	
Maximum transmission rate	230400bps
TCP connection	Max connection number>20
UDP connection	Max connection number>20
Serial baud rate	50~230400bps
Other Parameters	
Status indicator	Status indicator
Environmental standard	Operating temperature: -20-70℃
	Operating humidity: 10%-90%RH (noncondensing)
	Storage temperature: -40-80℃
	Storage humidity: 5%-90%RH (noncondensing)
Additional properties	Frequency bandwidth optional: 20MHz、40MHz, Automatic

2.2 Hardware Explanation

2.2.1 Mechanical Dimensions

HLK-RM04 *Mechanical* Dimensions is shown in the following picture:

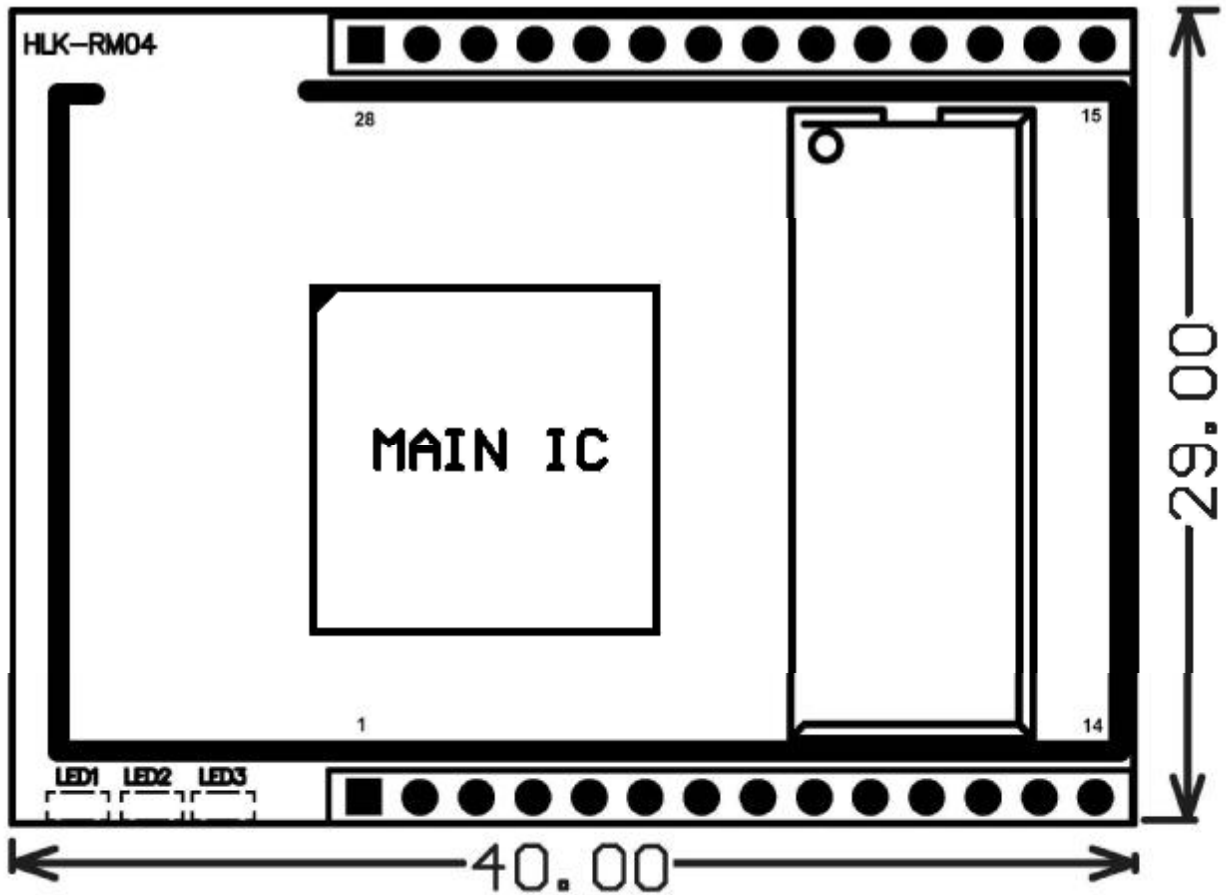

Picture2.Dimensions Unit:mm

2.2.2 Pins Interface

The Pin of this product as shown above is defined as follows:

Table2-2 module pin interface

No.	Function	Direction	Explanation
1	VDD5V	A	5 Power input
2	GND	GND	Power ground
3	GND	G	Serial sending
4	3.3V	I	3.3V power output
5	LINK1	I/O	Net gape 1 LED indicte
6	USB_P		USB signal
7	USB_M		USB signal
8	I2S_SD		I2C DATA/GPIO
9	I2S_CLK		I2C CLK/GPIO
10	GIOP0	I/O	Universal GPIO
11	TXOP1	I/O	Net gape 1 TX-P

12	TXON1	I/O	Net gape 1 TX-N
13	RXIP2	I/O	Net gape 2 RX-P
14	RXIN2	I/O	Net gape 2 RX-N
15	RXIN1	I/O	Net gape 1 RX-P
16	RXIP1	I/O	Net gape 1 RX-P
17	TXON2	I/O	Net gape 2 TX-N
18	TXOP2	I/O	Net gape 2 TX-P
19	RTS_N	I	All function serial RTS
20	UART_RX	I	Simple serial RX
21	UART_TX	O	Simple serial TX
22	RXD	I	All function serial RX
23	LINK2	I/O	Net gape 2 LED I/O indicto
24	CTS_N	O	All function serial CTS
25	RIN	I	GPIO
26	TXD	O	All function serial TX
27	1.8V	Power Out	Net gape 1.8V output
28	VDD5V	Power In	5V input

3 Quick Start

3.1 Restore factory settings

In order to ensure that all of configuration process is correct, bringing the module to restore the factory settings firstly. Factory mode, the module can skip this step. Above 5V (500mA) to power the module on the power, wait about 2.5 minutes for the system to start, after the start completion, pulled ES / RST pin down and make it surpass Trst, release ES / RST pin, the system will automatically restart. After rebooting, the system is already in Factory mode.

3.2 Configurate network parameter

Set the PC to static IP mode and then connect it with the module via Ethernet or wifi. The IP address is set to 192.168.16.100/255.255.255.0, gateway 192.168.16.254. The (wifi default ssid and the default password, see this document.) open the browser <http://192.168.16.254>, enter the web configuration page, default user name and password is admin / admin. Modify the network parameters through the web. Now, the module's IP address is 192.168.16.254. Configuration details can be seen in 5.1.

3.3 Configure serial network parameter

Opens the browser <http://192.168.16.254/ser2net.asp>, enter the serial-to-network web configuration page. Configure the serial-to-network parameters as needed through a web page. Configuration details can be seen in 5.2.

4 Function Description

The module can be divided into four major modes: default mode, serial to Ethernet, serial to WIFI CLIENT and serial to WIFI AP.

4.1 Serial to Ethernet

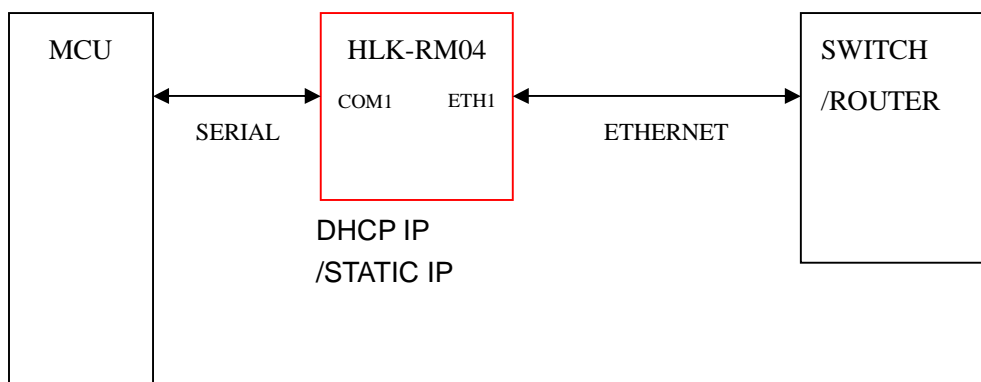

Chart3.serial to Ethernet model

In this mode, ETH1 enable, WIFI, ETH2 function close. Through the appropriate settings, the data between COM1 and ETH1 network can achieve mutual conversion.

Ethernet can be configured as dynamic IP address (DHCP), can also be configured as static IP address (STATIC).

4.2 Serial to WIFI CLIENT

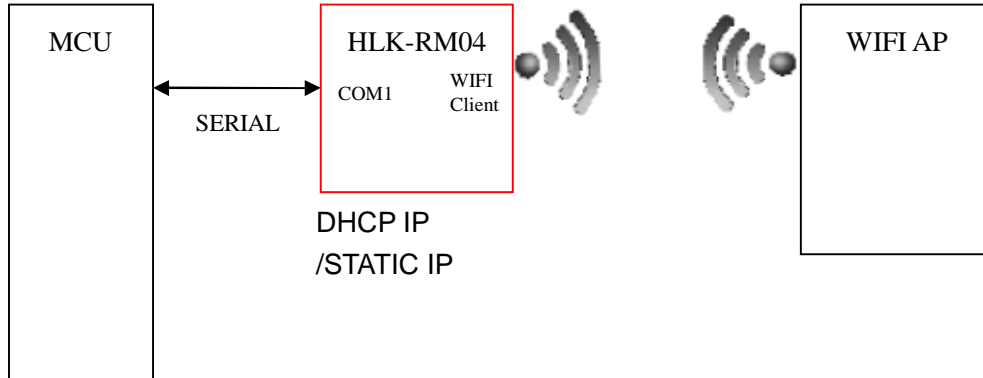

Chart 4.Serial to WIFI CLIENT model

In this mode, WIFI enable, module works in the client mode, ETH1, ETH2 function close. Through the appropriate settings, the data between COM1 and WIFI network can achieve mutual conversion.

WIFI CLIENT can be configured as dynamic IP address (DHCP), can also be configured as static IP address (STATIC).

WIFI safety: support all encryption methods at present.

4.3 Serial to WIFI AP

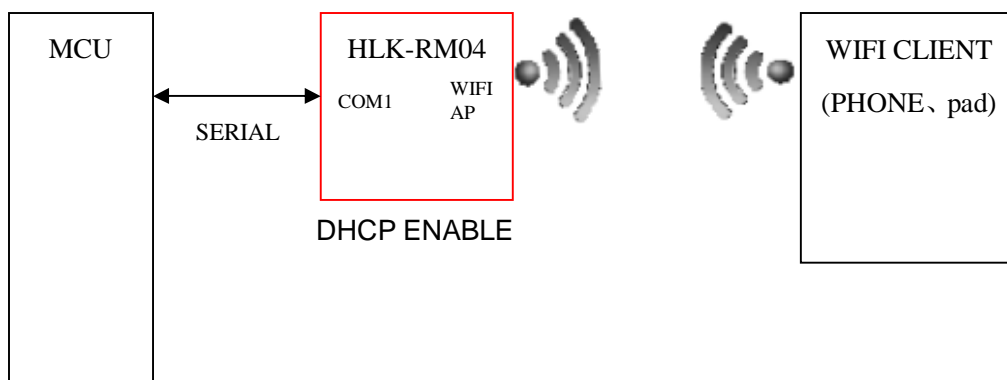

Chart 5. Serial to WIFI AP model

In this mode, WIFI enable, module works in the AP mode, ETH1, ETH2 function close.

Through the appropriate settings, the data between COM1 and WIFI network can achieve mutual conversion.

WIFI safety: support all encryption methods at present.

In this mode, WIFI device can connect with the module and become the device under WIFI LAN.

4.4 Default mode

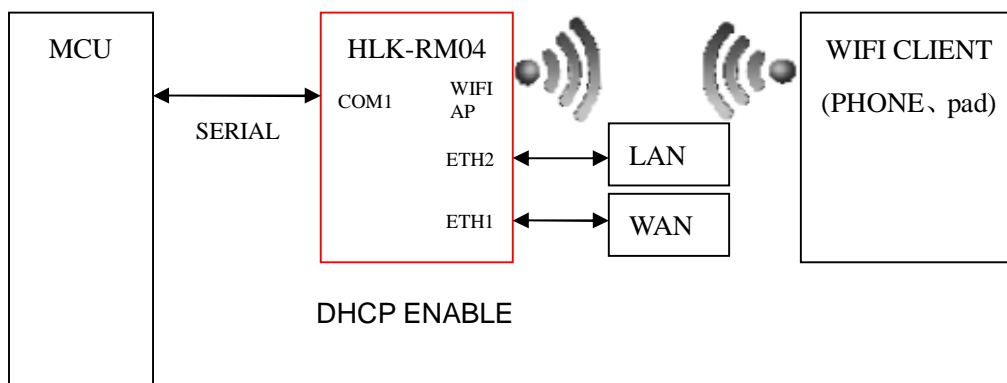

Chart 6.Default mode model

In this mode, WIFI enable, module works in the AP mode, ETH1, ETH2 function enable. ETH1 works as WAN, ETH2 works as LAN. Through the appropriate settings, the data between COM1 and network can achieve mutual conversion.

WIFI safety: support all encryption methods at present.

In this mode, WIFI device can connect with the module and become the device under WIFI LAN.

WAN default IP is dynamic IP address. LAN, WIFI for the same local area network, enabled by default DHCP server.

4.5 Parameter configuration direction

The module provides two ways for the configuration parameters:

1. Web page;
2. Serial AT command.

Access to WEB configuration page requires the confirmation of the module's IP addresses, as well as the user name and password that authenticated by WEB.

Configuring parameters through the serial port AT command needs to make the module into the AT command mode first.

Serial configuration tool HLK-RM04_CONFIG : Configure the module through AT command, provide a easier and convenient configuration process through the configuration combination of each parameter.

5 WEB configuration

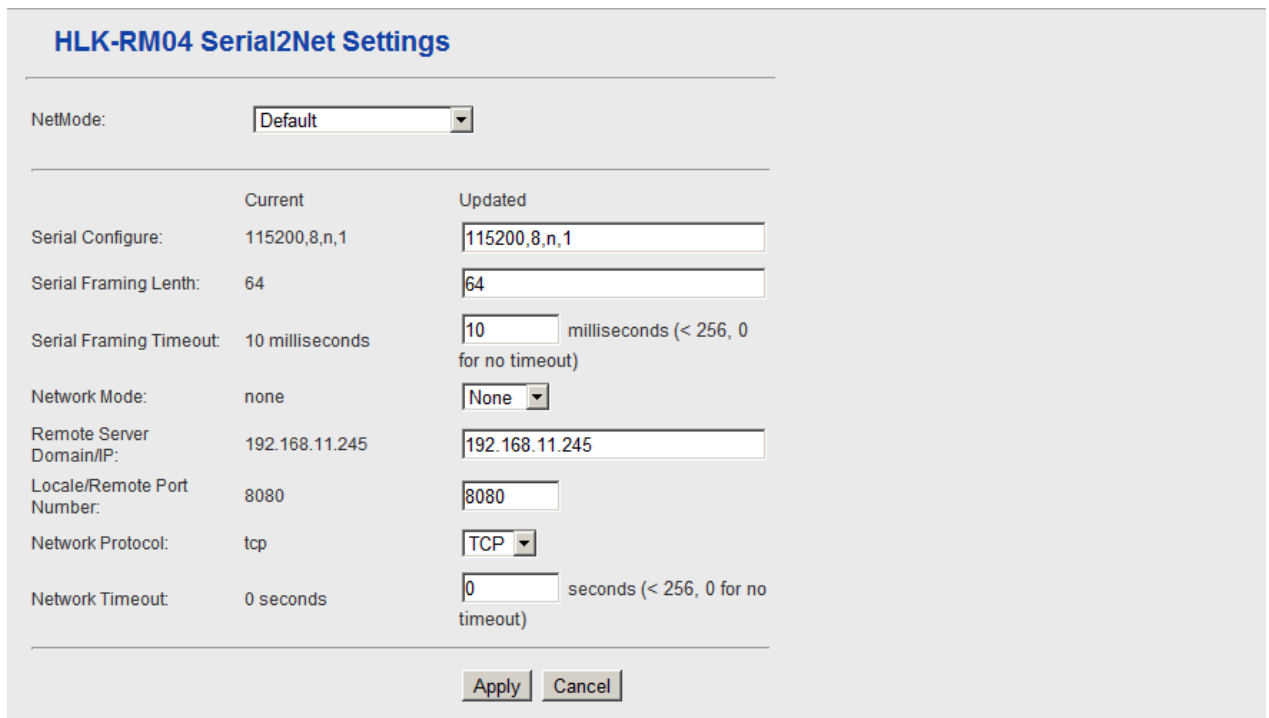

	Current	Updated
NetMode:	Default	Default
Serial Configure:	115200,8,n,1	115200,8,n,1
Serial Framing Lenth:	64	64
Serial Framing Timeout:	10 milliseconds	10 milliseconds (< 256, 0 for no timeout)
Network Mode:	none	None
Remote Server Domain/IP:	192.168.11.245	192.168.11.245
Locale/Remote Port Number:	8080	8080
Network Protocol:	tcp	TCP
Network Timeout:	0 seconds	0 seconds (< 256, 0 for no timeout)

Chart 7.WEB configuration page

Through the correct module address (default address:<http://192.168.16.254/ser2net.asp>),you can access to the WEB configuration page.

The page can be divided into 3 areas:

- 1 Network configuration area
- 2 Serial function configuration areas
- 3 Configuration submit area

5.1 WEB network configuration

Net mode selection:

- Default – default work mode
- ETH-SERIAL – Serial to Ethernet
- WIFI (CLIENT)-SERIAL – serial to WIFI CLIENT
- WIFI (AP)-SERIAL) – Serial to WIFI AP

Choose different work mode, the web will show you different page.Mode configuration page

is as follows:

5.1.1 Serial to Ethernet-dynamic ip

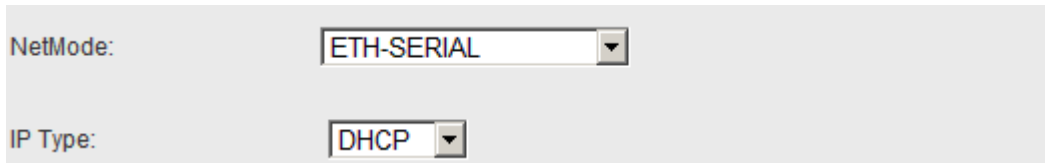

NetMode:	<input type="text" value="ETH-SERIAL"/>
IP Type:	<input type="text" value="DHCP"/>

Chart 8. Serial to Ethernet-dynamic

5.1.2 Serial to Ethernet-static ip

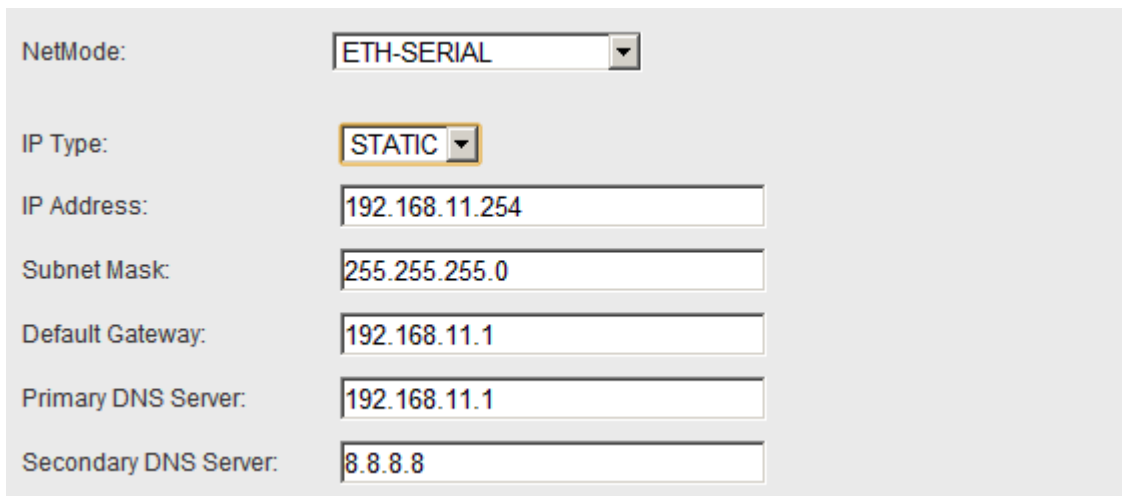

NetMode:	<input type="text" value="ETH-SERIAL"/>
IP Type:	<input type="text" value="STATIC"/>
IP Address:	<input type="text" value="192.168.11.254"/>
Subnet Mask:	<input type="text" value="255.255.255.0"/>
Default Gateway:	<input type="text" value="192.168.11.1"/>
Primary DNS Server:	<input type="text" value="192.168.11.1"/>
Secondary DNS Server:	<input type="text" value="8.8.8.8"/>

Chart 9. Serial to Ethernet-static

5.1.3 Serial to WIFI CLIENT-dynamic ip

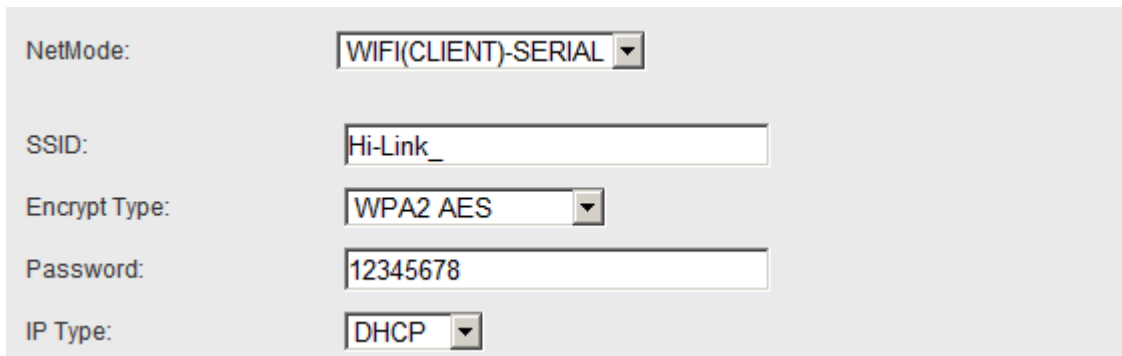

NetMode:	<input type="text" value="WIFI(CLIENT)-SERIAL"/>
SSID:	<input type="text" value="Hi-Link_"/>
Encrypt Type:	<input type="text" value="WPA2 AES"/>
Password:	<input type="text" value="12345678"/>
IP Type:	<input type="text" value="DHCP"/>

Chart 10. serial to WIFI CLIENT dynamic

5.1.4 Serial to WIFI CLIENT-static ip

NetMode:	WIFI(CLIENT)-SERIAL
SSID:	Hi-Link_
Encrypt Type:	WPA2 AES
Password:	12345678
IP Type:	STATIC
IP Address:	192.168.11.254
Subnet Mask:	255.255.255.0
Default Gateway:	192.168.11.1
Primary DNS Server:	192.168.11.1
Secondary DNS Server:	8.8.8.8

Chart 11. Serial to WIFI CLIENT-static

5.1.5 Serial to WIFI AP

NetMode:	WIFI(AP)-SERIAL
SSID:	Hi-Link_
Encrypt Type:	WPA2 AES
Password:	12345678
IP Address:	192.168.11.254
Subnet Mask:	255.255.255.0

Chart12. Serial to WIFI AP

5.2 WEB serial configuration

Serial Web configuration page (ser2net.asp) is as follows:

Serial Settings

	Current	Updated
Serial Configure:	115200,8,n,1	<input type="text" value="115200,8,n,1"/>
Serial Framing Lenth:	64	<input type="text" value="64"/>
Serial Framing Timeout:	10 milliseconds	<input type="text" value="10"/> milliseconds (< 256, 0 for no timeout)
Network Mode:	client	<input type="text" value="Client"/>
Remote Server Domain/IP:	192.168.11.245	<input type="text" value="192.168.11.245"/>
Locale/Remote Port Number:	8080	<input type="text" value="8080"/>
Network Protocol:	udp	<input type="text" value="UDP"/>
Network Timeout:	0 seconds	<input type="text" value="0"/> seconds (< 256, 0 for no timeout)
		<input type="button" value="Submit"/>

Current shows the current configuration , **Updated** shows the current revision parameters。
Submit submit the revision.

Serial Configure: Serial configuration.fomat: Baud rate, data bits, parity bit, stop bit.
For example: “115200,8,n,1”.

Serial Framing Lenth: The Lenth of Serial Framing

Serial Framing Timeout: The time of Serial Framing

Network Mode: choose Client、Server or none。

Remote Server Domain/IP: Remote Server Domain/IP address

For expmale: 192.168.11.245 or www.hlktech.com .

Locale/Remote Port Number: The specified parameter is not the same under the different network modes. Client specifies the port number on the remote, Server specified local port number.

Network Protocol: Use tcp or udp Protocol

Network Timeout: Under the server network mode, no data transmission within the timeout period, the connection will be disconnected. 0 specifies never disconnected.

6 Serial AT command configuration

6.1 Access to AT command mode

Module in network fault, such as fault allocation situation will automatically exit the transparent transmission mode, enter AT instruction mode. In any condition, keep ES/RST feet low level of time but more than T_{es} and less than T_{rst} , the module will enter AT instruction mode immediately.

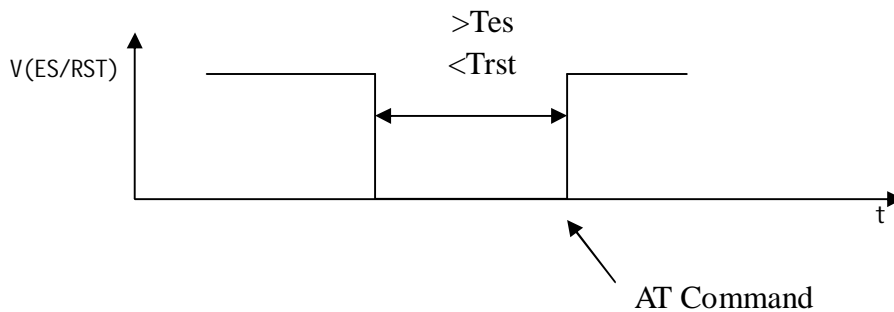

6.2 AT Command

In AT mode, you can configure the system parameters through the serial port AT instruction. Instruction format is as follows:

`At+[command]=[value]\r`

According to the different command, module will return a different return value.

For example: "at+remoteip=192.168.11.133\n" set remote ip address as 192.168.11.133.

For example: "at+remoteip=? \n" Inquiry remote ip address.

At command is as follows:

netmode	Network mode
wifi_conf	Wifi configuration
dhcpc	Dhcp client configuration
net_ip	Network ip address

net_dns	Network dns address
dhcpd	Dhcp server configuration
dhcpd_ip	Dhcp server ip address
dhcpd_dns	Dhcp server dns address
dhcpd_time	Dhcp sever time allocation
net_commit	Submit network configuration
out_trans	Exit transparent transmission mode
remoteip	Remote server domain name or IP address
remoteport	The local or distal port number
remotepro	Network Protocol type
timeout	Network timeout
mode	Network mode
uart	Serial port configuration
uartpacklen	Serial group frame length
uartpacktimeout	Serial framing time
save	Save the configuration and start service
reconn	Restart services
default	Restore factory value settings
reboot	Restart the module
ver	The version of module

6.2.1 Net mode

Function:

Network mode setting

Format:

At+netmode=<netmode>\r

Parameters:

Table 6-3 network mode

value	meaning
0	Default setup
1	Ethernet
2	Wifi client
3	Wifi ap

6.2.2 wifi_conf

Function:

Wireless parameter setting

Format:

At+wifi_conf=<ssid>, <encrypt type>, <password> \r

Parameters:

ssid: Network SSID

Encrypt type: Encryption mode

Table 6-4 Encryption mode

value	meaning
none	Open network
wep_open	Wep encryption, open authentication method
wep	Wep encryption, encryption authentication
wpa_tkip	wpa tkip
wpa_aes	wpa aes
wpa2_tkip	wpa2 tkip
wpa2_aes	wpa2 aes
wpawpa2_tkip	wpa/wpa2 tkip
wpawpa2_aes	wpa/wpa2 aes

6.2.3 dhcpc

Function:

Dhcp client enable

Format:

At+dhcpc=<dhcpc>\r

Parameters:

Table 6-5 Dhcp client enable

value	meaning
0	Static ip address
1	Dynamic ip address

6.2.4 net_ip

Function:

Network mode setting

This parameter is not valid when Dhcp client feature is turned on.

Format:

At+Net_ip=<ip>, <mask>, <gateway>\r

Parameters:

Ip: Ip address

Mask: Subnet mask

Gateway: Gateway Network Element

6.2.5 net_dns

Function:

Network mode setting

This parameter is not valid when Dhcp client feature is turned on

Format:

At+Net_dns=<dns1>, <dns2>\r

parameters:

dns1: Major DNS address

dns2: Minor DNS address

6.2.6 dhcpd

Function:

Dhcp server enable

This parameter is not valid when the network mode is AP.

Format:

At+dhcpd=<dhcpd>\r

Parameters:

Table 6-6 Dhcp servers enable

value	meaning
0	close
1	open

6.2.7 dhcpd_ip

Function:

Dhcp server IP setting

Format:

At+Dhcpd_ip=<ip start>, <ip end>, <mask>, <gateway>\r

parameters:

Ip start: Ip started address

Ip end: Ip ended address

Mask: Subnet mask

Gateway: Gateway Network Element

6.2.8 dhcpd_dns

Function:

Dhcp server dns setting

Format:

At+Dhcpd_dns=<dns1>, <dns2>\r

Parameters:

dns1: Major dns address

dns2: Minor dns address

6.2.9 dhcpd_time

Function:

Dhcp server time setting

Format:

At+Dhcpd_time=<time >\r

Parameters:

time: Dhcp effective time assigned to device.

6.2.10 net_commit

Function:

Submit to network setting

Network configuration parameters set to be submitted by this parameter to save the entry into force.

Format:

At+ Net_commit=< Net_commit >\r

Parameters:

Table 6-7 submit to network setting

value	meaning
0	invalid
1	submit

6.2.11 out_trans

Function:

Exit the transparent transmission mode

Format:

At+out_trans=<out_trans>\r

Parameters:

Table 6-8 Exit the transparent transmission mode

value	meaning
Arbitrarily	Exit the transparent transmission mode

6.2.12 remoteip

Function:

Remote ip or domain name setting

Format:

At+remoteip=< remoteip >\r

Parameters:

Remote server domain name or IP address

6.2.13 remoteport

Function:

Remote port setting

Format:

At+ remoteport=<remoteport>\r

Parameters:

Remoteport: Remote port

6.2.14 remotepro

Function:

Protocol Type setting

Format:

At+remotepro=<remotepro>\r

Parameters:

Table 6-9 remotepro parameters setting

value	meaning
None	No protocol
Tcp	Tcp protocol
Udp	Udp protocol

6.2.15 timeout

Function

Network time-out

Format:

At+timeout=<timeout>\r

Parameters:

Network time-out server

Network mode, when there is not any data transfer during the time-out, the connection will be disconnected. 0 specifies never disconnected.

6.2.16 mode

Function:

The conversion mode setting

Format:

At+mode=<mode>\r

Parameters:

Table 6-10 mode setting

value	meaning
None	No protocol
Client	Tcp protocol
Server	Udp protocol

6.2.17 uart

Function:

Serial configuration setting

Format:

At+uart=<baud>, <data>, <parity>, <stop>\r

parameters:

Baud: Baud rate

Data: Data bits

Parity: Parity bit

Stop: length of stop bit

6.2.18 uartpacklen

Function:

Serial framing length setting

Format:

At+uartpacklen =<uartpacklen>\r

Parameters:

uartpacklen: Serial framing length (Unit: bit) .Default value: 64.

6.2.19 uartpacktimeout

Function:

Serial framing time setting

Format:

At+ uartpacktimeout=<uartpacktimeout>\r

Parameters:

uartpacktimeout: Serial framing time (unit: ms)。 Default value:10

6.2.20 save

Function:

Submitted to serial converter configuration and restart the service.

Format:

At+ save=<save>\r

Parameters:

Table 6-11 submit to network setting

value	meaning
-------	---------

0	invalid
1	submit

6.2.21 reconn

Function:

Restart serial transformation service

Format:

At+ reconn =< reconn >\r

Parameters:

Table 6-12 reconn

value	meaning
arbitrarily	Restart serial transformation service

6.2.22 ver

Function:

Inquiry the firmware version

Format:

At+ ver =? \r

Parameters:

None

6.3 AT command control code roution

6.3.1 Inquiry configuration information

Code:

```
char *query="\
at+netmode=?\r\n\
at+wifi_conf=?\r\n\
at+dhcpcd=?\r\n\
at+dhcpcd_ip=?\r\n\
at+dhcpcd_dns=?\r\n\
at+dhcpcd_time=?\r\n\
at+dhcpc=?\r\n\
at+net_ip=?\r\n\
at+net_dns=?\r\n\
at+net_wanip=?\r\n\
\
```



```
at+remoteip=?\r\n\  
at+remoteport=?\r\n\  
at+remotepro=?\r\n\  
at+timeout=?\r\n\  
at+mode=?\r\n\  
at+uart=?\r\n\  
at+uartpacklen=?\r\n\  
at+uartpacktimeout=?\r\n\  
at+ver=?\r\n\  
";
```

```
Com_send(query);
```

Run,return:

```
at+netmode=? 0  
at+wifi_conf=? Hi-Link,wpa2_aes,12345678  
at+dhcpc=? 0  
at+dhcpc_ip=? 192.168.14.1,192.168.15.254,255.255.254.0,192.168.15.254  
at+dhcpc_dns=? 192.168.15.254,0.0.0.0  
at+dhcpc_time=? 86400  
at+dhcpc=? 1  
at+net_ip=? 192.168.15.254,255.255.254.0,192.168.11.1  
at+net_dns=? 192.168.11.1,0.0.0.0  
at+net_wanip=? ,,  
at+remoteip=? 192.168.11.245  
at+remoteport=? 8080  
at+remotepro=? tcp  
at+timeout=? 0  
at+mode=? server  
at+uart=? 115200,8,n,1  
at+uartpacklen=? 64  
at+uartpacktimeout=? 10  
at+ver=? V1.39(Dec 6 2012)
```

6.3.2 Serial to Ethernet(Dynamic ip address)

Code:

```
char *commands_eth="\n\  
at+netmode=1\r\n\  
at+dhcpc=1\r\n\  
at+remoteip=192.168.11.245\r\n\  
at+remoteport=8080\r\n\  
"
```

```
at+remotepro=tcp\r\n\  
at+timeout=0\r\n\  
at+mode=server\r\n\  
at+uart=115200,8,n,1\r\n\  
at+uartpacklen=64\r\n\  
at+uartpacktimeout=10\r\n\  
at+net_commit=1\r\n\  
at+reconn=1\r\n\  
";
```

```
Com_send(commands_eth);
```

Run and return:

```
at+netmode=1 ok  
at+dhcpc=1  
at+remoteip=192.168.11.245 ok  
at+remoteport=8080 ok  
at+remotepro=tcp  
at+timeout=0 ok  
at+mode=server  
at+uart=115200,8,n,1 ok  
at+uartpacklen=64 ok  
at+uartpacktimeout=10 ok  
at+net_commit=1
```

6.3.3 Serial to Ethernet(static ip address)

Code:

```
char *commands_eth_static="\n\  
at+netmode=1\r\n\  
at+dhcpc=0\r\n\  
at+net_ip=192.168.11.254,255.255.255.0,192.168.11.1\r\n\  
at+net_dns=192.168.11.1,8.8.8.8\r\n\  
\n\  
at+remoteip=192.168.11.245\r\n\  
at+remoteport=8080\r\n\  
at+remotepro=tcp\r\n\  
at+timeout=0\r\n\  
at+mode=server\r\n\  
at+uart=115200,8,n,1\r\n\  
at+uartpacklen=64\r\n\  
at+uartpacktimeout=10\r\n\  
at+net_commit=1\r\n\  
\n\  
";
```

```
at+reconn=1\r\n\  
";
```

```
Com_send(commands_eth_static);
```

Run and return:

```
at+netmode=1 ok  
at+dhcpc=0  
at+net_ip=192.168.11.254,255.255.255.0,192.168.11.1 ok  
at+net_dns=192.168.11.1,8.8.8.8 ok  
at+remoteip=192.168.11.245 ok  
at+remoteport=8080 ok  
at+remotepro=tcp  
at+timeout=0 ok  
at+mode=server  
at+uart=115200,8,n,1 ok  
at+uartpacklen=64 ok  
at+uartpacktimeout=10 ok  
at+net_commit=1
```

6.3.4 Serial to wifi client(dynamic IP address)

Code:

```
char *commands_wifi_client="\n\  
at+netmode=2\r\n\  
at+wifi_conf=HI-LINK,wpa2_aes,12345678\r\n\  
at+dhcpc=1\r\n\  
\n\  
at+remoteip=192.168.11.245\r\n\  
at+remoteport=8080\r\n\  
at+remotepro=tcp\r\n\  
at+timeout=0\r\n\  
at+mode=server\r\n\  
at+uart=115200,8,n,1\r\n\  
at+uartpacklen=64\r\n\  
at+uartpacktimeout=10\r\n\  
at+net_commit=1\r\n\  
at+reconn=1\r\n\  
";
```

```
Com_send(commands_wifi_client);
```

Run and return:

```
at+netmode=2 ok
at+wifi_conf=HI-LINK,wpa2_aes,12345678 ok
at+dhcpc=1
at+remoteip=192.168.11.245 ok
at+remoteport=8080 ok
at+remotepro=tcp
at+timeout=0 ok
at+mode=server
at+uart=115200,8,n,1 ok
at+uartpacklen=64 ok
at+uartpacktimeout=10 ok
at+net_commit=1
```

6.3.5 Serial to wifi client(static IP address)

Code:

```
char *commands_wifi_client_static="\
at+netmode=2\r\n\
at+wifi_conf=HI-LINK,wpa2_aes,12345678\r\n\
at+dhcpc=0\r\n\
at+net_ip=192.168.11.254,255.255.255.0,192.168.11.1\r\n\
at+net_dns=192.168.11.1,8.8.8.8\r\n\
\
at+remoteip=192.168.11.245\r\n\
at+remoteport=8080\r\n\
at+remotepro=tcp\r\n\
at+timeout=0\r\n\
at+mode=server\r\n\
at+uart=115200,8,n,1\r\n\
at+uartpacklen=64\r\n\
at+uartpacktimeout=10\r\n\
at+net_commit=1\r\n\
at+reconn=1\r\n\
";
```

```
Com_send(commands_wifi_client_static);
```

Run and return:

```
at+netmode=2 ok
at+wifi_conf=HI-LINK,wpa2_aes,12345678 ok
at+dhcpc=0
at+net_ip=192.168.11.254,255.255.255.0,192.168.11.1 ok
at+net_dns=192.168.11.1,8.8.8.8 ok
```

```
at+remoteip=192.168.11.245 ok
at+remoteport=8080 ok
at+remotepro=tcp
at+timeout=0 ok
at+mode=server
at+uart=115200,8,n,1 ok
at+uartpacklen=64 ok
at+uartpacktimeout=10 ok
at+net_commit=1
```

6.3.6 Serial to wifi AP

Code:

```
char *commands_wifi_ap="\
at+netmode=3\r\n\
at+wifi_conf=Hi-Link_,wpa2_aes,0000000000\r\n\
at+dhcpcd=1\r\n\
at+dhcpcd_ip=192.168.16.100,192.168.16.200,255.255.255.0,192.168.16.254\r\n\
at+dhcpcd_dns=192.168.16.254,8.8.8.8\r\n\
at+dhcpcd_time=86400\r\n\
at+net_ip=192.168.16.254,255.255.255.0,192.168.16.254\r\n\
at+net_dns=192.168.16.254,8.8.8.8\r\n\
\
at+remoteip=192.168.11.245\r\n\
at+remoteport=8080\r\n\
at+remotepro=tcp\r\n\
at+timeout=0\r\n\
at+mode=server\r\n\
at+uart=115200,8,n,1\r\n\
at+uartpacklen=64\r\n\
at+uartpacktimeout=10\r\n\
at+net_commit=1\r\n\
at+reconn=1\r\n\
";
```

```
Com_send(commands_wifi_ap);
```

Run and return:

```
at+netmode=3 ok
at+wifi_conf=Hi-Link_,wpa2_aes,0000000000 ok
at+dhcpcd=1 ok
at+dhcpcd_ip=192.168.16.100,192.168.16.200,255.255.255.0,192.168.16.254 ok
at+dhcpcd_dns=192.168.16.254,8.8.8.8 ok
```

```
at+dhcpcd_time=86400 ok
at+net_ip=192.168.16.254,255.255.255.0,192.168.16.254 ok
at+net_dns=192.168.16.254,8.8.8.8 ok
at+remoteip=192.168.11.245 ok
at+remoteport=8080 ok
at+remoteproto=tcp
at+timeout=0 ok
at+mode=server
at+uart=115200,8,n,1 ok
at+uartpacklen=64 ok
at+uartpacktimeout=10 ok
at+net_commit=1
```

6.3.7 Restore factory value

Code:

```
char *commands_device_default="\
\
at+default=1\r\n\
at+reboot=1\r\n\
";
```

```
Com_send(commands_device_default);
```

Run and return:

```
at+default=1
```

After 30s, the modules start normally, all configuration parameters change to the factory configuration.

7 Serial configuration tools

HLK-RM04 CONFIG is a configuration tools that configurate the module through the serial port. Tool interface is as follows:

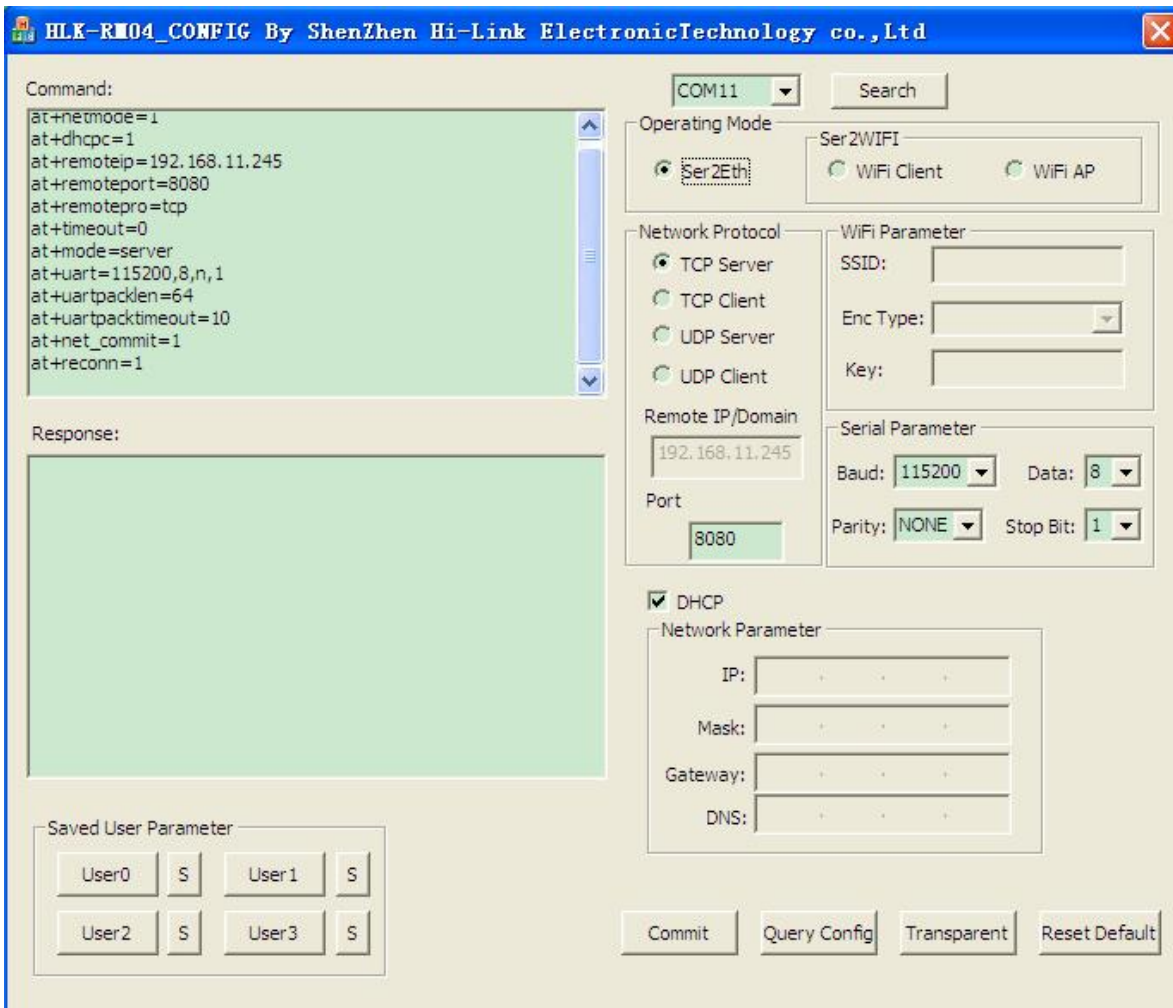

Chart 13 Configuration tools interface

Description:

1. 'Com 11' stands for configuration serial option
2. Search: module searching button
3. Operation mode: work mode selection
4. Wifi Parameter: wireless parameter configuration
5. Network Protocol: Network protocol selection
6. Serial Parameter: Serial parameter configuration
7. IP: Network IP address configuration
8. Commit: submit the configuration
9. Query config: Inquiry the configuration
10. Transparent: Access to transparent transmission mode
11. Reset Default: Restore the factory value setting
12. Saved User Parameter: User parameter holding area
13. Command: Ready for sent AT instruction area

14. Response: AT instruction return information area

7.1 Searching the Module

Through the "configure serial port choice" choose PC serial number and click on the "search module" button, the tool will use the specified serial search the module HLK - RM04, the module will be searched if it has been connected and in AT instruction mode . The module information will be found in the AT instruction return information area. Shown as below:

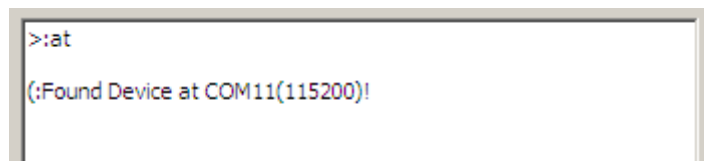

```
>:at  
(:Found Device at COM11(115200)!
```

Chart 16 searching the module

At this time, The PC and module have been able to establish the normal AT command communication. All the AT interactive orders need to process based on the normal AT instruction communication.

7.2 Set each Parameters

Configure the required function through the configuration items 3, 4, 5, 6, 7. The Configuration and modification information would immediately create the matching AT command in the ready for sent AT instruction area. The generated AT instruction will not send to the module at once. Shown as below:

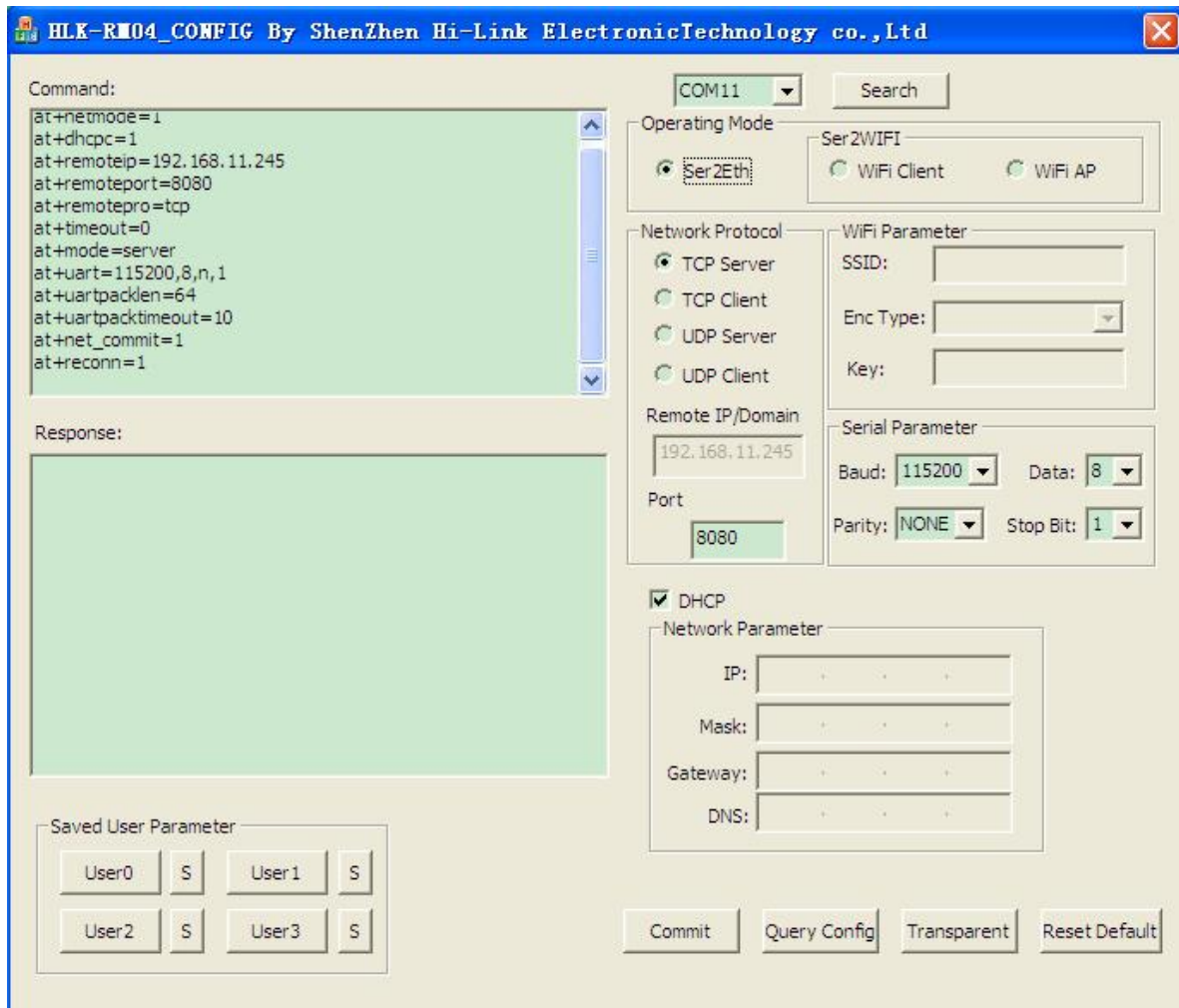

Chart 17 Serial configuration tool generates AT command

7.3 Submit the configuration

Click the submit configuration button, the tool will send the AT instruction in the ready for sent area to the module immediately. The information of command execution results will be shown in AT instruction return information area.

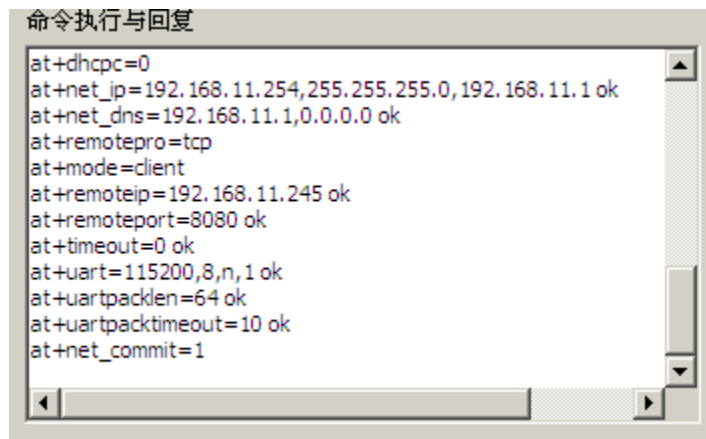

Chart18. Serial configuration tools instruction execution

7.4 User Data Retention

The user parameter holding area provides parameter saving function. Through this function you can save up four sets of parameters at most, respectively, user0 user1, user2, user3. Click "S" button, it will pop up a confirmation dialog shown as below:



Chart 19. Pop-up Dialog of parameter saving

Click on the button "yes", the instruction in the ready for sent AT instruction area will save for user0 parameter group. After this step, when you click "user0" anytime, this parameter group can be called immediately, and covered to the ready for sent AT instruction area.

The stored user parameter will save as text file in the tools contents, file name, respectively, user0, user1, user2, user3.

7.5 Inquiry configuration

Click on the button 'inquiry', The tool will send a series of AT instructions immediately to the module to inquire the current configuration of the module, the result of execution will show in AT instruction return information area at once, each configuration items will make corresponding change with the return information.

7.6 Access to transparent transmission mode

If the module has already in the AT instruction mode, click on the button 'T/T', you can access to the transparent transmission mode at once.

7.7 Restore factory factory value setting

Click on the button 'reset', the tool will pop up a confirmed box shown as below:



Chart 20 Pop-up box for reset default setting

Click on the button 'yes', The tools will send AT instruction immediately, after about 30 seconds, the module will access to the default state.

8 Device Search tools

HLK-RM04_Discover is a search tool of network end used to search the module HLK-RM04. The interface is as follows:

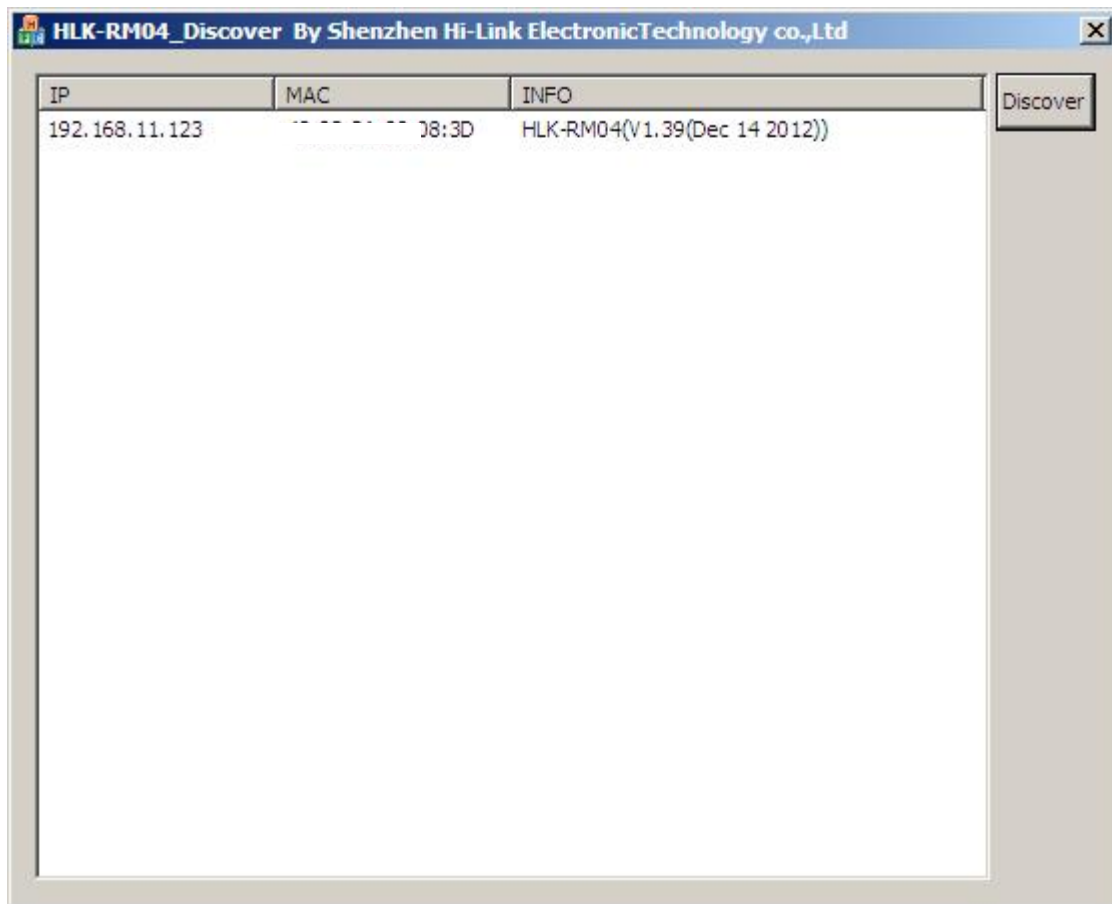

Chart 21. Device search tools

Click on the button "Discover", the tools will search all the HLK-RM04 module connected with PC in the LAN. The module being searched will show in the information box soon. The module information including: IP address, MAC address and version of it.

9 Restore factory Settings

Support the following ways to restore the factory settings

1. Through the Web page.
- 2 By keeping the ES/RST pin low level time greater than Trst.

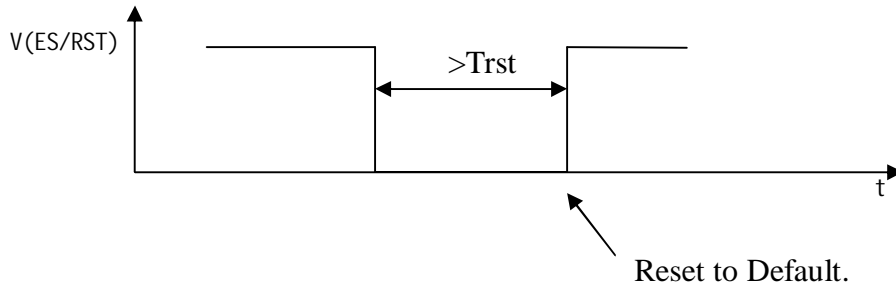

Factory setting parameter values, see the following list:

netmode	0
wifi_conf	Hi-Link_,wpa2_aes,12345678
dhcpc	1
net_ip	192.168.11.254,255.255.255.0,192.168.11.1
net_dns	192.168.11.1,8.8.8.8
dhcpcd	1
dhcpcd_ip	192.168.16.100,192.168.16.200,255.255.255.0,192.168.16.1
dhcpcd_dns	192.168.16.1,8.8.8.8
dhcpcd_time	86400
remoteip	192.168.11.245
remoteport	8080
remotepro	tcp
timeout	0
mode	none
uart	115200,8,n,1
uartpacklen	64
uartpacktimeout	10
IP address	192.168.16.254
Wifi password	12345678
Web username/password	admin/admin

Tes	100ms
Trst	6s

10 Firmware upgrade

1. Restore the factory value.
2. Pc can connect with module through Ethernet, ip: 192.168.16.123/255.255.255.0. Browser visits 192.168.16.254. Username / password: admin / admin.
3. Open the following page. Select the appropriate firmware, click apply upgrades. Wait about 3 minutes. Can not cut out the upgrade process, otherwise it may cause damage to the module.



Appendix A document revision record

Version number	Revision range	Date
1.00	Draft version	2012-9-10