

atrin **electronic**

Expertise, variety and quality



www.atrinelec.com

آترین الکترونیک

تخصص، تنوع و کیفیت

02166766957 - 02166766927



info@atrinelec.com



تهران پاساژ امجد طبقه 1 واحد 16



@atrinelec



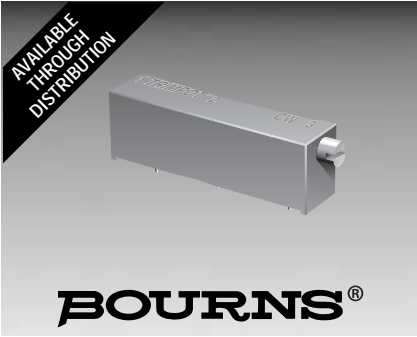

Features

- 3/4 " Rectangular / Multiturn Cermet / Industrial / Sealed
- Low PC board profile - only 1/4 " high
- [Panel mount option](#) available
- Transparent housing available, can be set visually without hook-up and instrumentation ("P" style only)

3006 - Trimpot® Trimming Potentiometer

Electrical Characteristics

Standard Resistance Range 10 to 5 megohms
 (see standard resistance table)
 Resistance Tolerance ±10 % std.
 (tighter tolerance available)
 Absolute Minimum Resistance 1.0 % or 2 ohms max.
 (whichever is greater)
 Contact Resistance Variation 1.0 % or 1 ohm max.
 (whichever is greater)
 Adjustability
 Voltage ±0.01 %
 Resistance ±0.05 %
 Resolution Infinite
 Insulation Resistance 500 vdc.
 1,000 megohms min.

Dielectric Strength
 Sea Level 1,000 vac
 80,000 Feet 250 vac
 Adjustment Angle 15 turns nom.

Environmental Characteristics

Power Rating (400 volts max.)
 70 °C 0.75 watt
 125 °C 0 watt
 Temperature Range -55 °C to +125 °C
 Temperature Coefficient ±100 ppm/°C
 Seal Test 85 °C Fluorinert*
 Humidity MIL-STD-202 Method 103
 96 hours
 (3 % ΔTR, 20 Megohms IR)
 Vibration 20 G (2 % ΔTR; 2 % ΔVR)
 Shock 50 G (2 % ΔTR; 2 % ΔVR)
 Load Life ... 1,000 hours 0.75 watt 70 °C
 (4 % ΔTR)
 Rotational Life 200 cycles
 (3 % ΔTR; 1 % or 1 ohm,
 whichever is greater, CRV)

Physical Characteristics

Torque 5.0 oz-in. max.
 Mechanical Stops Wiper idles
 Terminals Solderable pins
 Weight 0.04 oz.
 Marking Manufacturer's
 trademark, resistance code,
 terminal numbers, date code,
 manufacturer's model number
 and style
 Wiper Positioning 50 % nominal
 Flammability U.L. 94V-0
 Standard Packaging 25 pcs. per tube
 Adjustment Tool H-90

*"FLUORINERT" IS A REGISTERED TRADEMARK OF 3M CO.

Common Dimensions

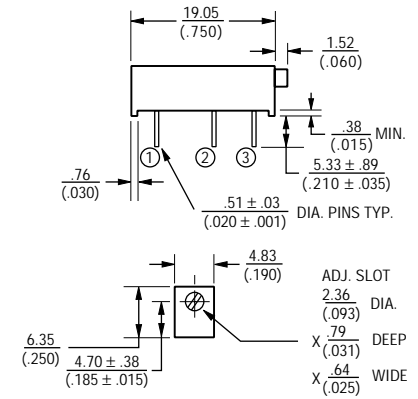

3006P

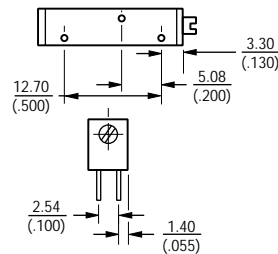

3006W

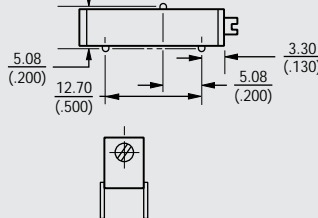

3006Y

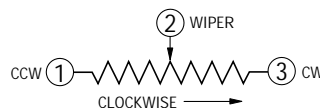
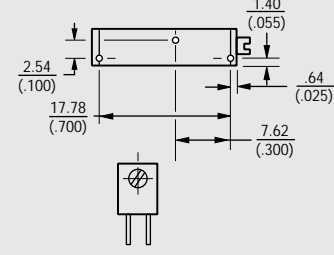

How To Order

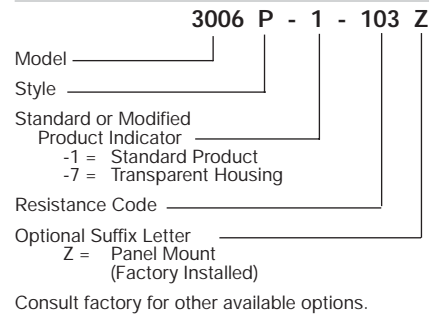

Standard Resistance Table

Resistance (Ohms)	Resistance Code
10	100
20	200
50	500
100	101
200	201
500	501
1,000	102
2,000	202
5,000	502
10,000	103
20,000	203
25,000	253
50,000	503
100,000	104
200,000	204
250,000	254
500,000	504
1,000,000	105
2,000,000	205

Popular values listed in boldface. Special resistances available.

SHADED AREAS TYPICALLY NOT STOCKED BY DISTRIBUTORS AND NOT RECOMMENDED FOR NEW DESIGNS.

TOLERANCES: ± 0.25 (.010) EXCEPT WHERE NOTED

DIMENSIONS ARE: $\frac{\text{MM}}{\text{(INCHES)}}$